



CRESCENT
garden

CRESCENT
garden

CELEBRATING
25 YEARS



About Us	04
Catalog and Program Details	10



Crescent Garden HF System 12

Ferrum Perforated Planters	22
Ferrum Rectangular and Tall Planters	24
Ferrum Round Planters	26
Ferrum Square Planters	28
Fuse Family of Planters and Furniture	32
Lin Planters	36
Lux Planters	38
Taurus Planters	40
Accessory Replacements for HF	42



TruDrop One Self-Watering Planters 48

Cup Tall Planters	60
Dot Planters	62
Mod Family of Planters	66
Nest Planters	72
Pinch Planters	78
Rim Planters	82
Slat Planters	88
Slat Window Boxes	90
TruDrop One - Add-ons for Pinch and Slate Planters ...	92
TruDrop One - Easy Drain System	95
Replacement Parts for TruDrop Planters	97



TruDrop Flex Self-Watering Planters Circular + 98

NEW ⊕ Fold Planters	106
NEW ⊕ Ridge Planters	108
NEW ⊕ Step Planters	112
NEW ⊕ TruDrop Flex - Insert and Water Gauge	114



10 Year Warranty Planters 116

Agave Planters	126
Bleeker Planters	128
Bowery Planters	132
Brunello Rolled-Rim Planters	134
Delano Planters	136
Delano Oval Bowls	138
Delano Tall Planter	140
Eye Planters	144
Fold Planters	146
Leyla Urn	148
Madison Planters	152
Origami Planters	156
Orinoco Bowls	158
Pleat Planters	164
Ridge Planters	166
Step Planters	168



Everyday Planters 170

Eva Planters	172
--------------------	-----



Mobility and Drainage Solutions 174

Pebble Plant Caddies	178
Universal Round and Square Saucers	180



Our Customer Promise

When Paula Douer and Harry Tchira created Crescent Garden in 1999, they were skilled in manufacturing and design, and while enthusiastic about gardening they weren't yet experts. They set about listening, learning, and discovering from industry friends and colleagues what's needed for gardens and gardeners to thrive. 25 years later, the Crescent Garden Company is a popular and progressive home and garden provider, bringing together a premier container gardening brand, a pioneer in self-watering and sustainable solutions. The company culture is powered by people who are professional, passionate and always in their customers' corner.

Lead brand Crescent Garden, trusted by contractors, designers, plant experts, independent garden centers and nurseries, offers containers and accessories distinguished by refined design and breakthrough innovation that lasts and lasts, for successful, inspired gardening.

Their pioneering TruDrop™ system engineers self-watering planters to go up to weeks without watering, for phenomenal results and more confident gardeners. TruDrop dramatically transforms the way people care for plants.

Crescent Too, available across garden centers, popular retailers and online, brings attractive and useful containers and supplies that make gardening easier and more rewarding to more people, at excellent value.

Crescent Garden believes that planters should work for you, not the other way around, and directs their R&D on design and innovation that pushes the envelope, legendary reliability and durability in whatever season, and understanding what works best for healthy plants and the people who love them.

With a vision to make gardening more accessible and relevant to everyone, while going beyond industry standards for what's possible, the Crescent Garden Company dedicates everything toward a simple customer promise:

we help you grow

CRESCENT *garden*

Crescent Garden planters are defined by their refined design and breakthrough innovation that lasts and lasts for successful, inspired gardening.



All encompassing TruDrop
One self-watering



Inspired solutions with
design in mind



Timeless design



Trend-setting style

CRESCENT *garden*

Our Crescent Garden HF
planters are fabricated in
Spain from exceptional
materials.

Crescent**TOO**

Attractive and useful
planters that make gardening
easier and more rewarding
for more people



From glossy metals, to rich
leathers these planters.



Versatile self-watering with
TruDrop Flex



Enhance any residential or
commercial property.



Everyday planters
well-made

At Crescent Garden, sustainability begins with a distinct sensibility — a circular, continuous approach for positive impact wherever we can make a difference. We look at everything in harmony, inside and out, over time.

Surrounding our products are processes and policies, for a holistic approach to lessening our own environmental footprint, which in turn can result in more climate-positive outcomes in our retailer and customer communities.

Whether it's internal ways of working, how we source, make and distribute, or how gardeners use, dispose, and recycle, we want to help everyone grow, more sustainably.

Centered on the lifecycle of our products

Our R&D lifecycle is circular from the outset: Materials / Manufacturing / Distribution / Customer Experience. Thoughtful resource use and innovations in product development, energy-efficient manufacturing, reducing our shipping carbon footprint, ecological emphasis in product use and advice, and responsible disposal and reuse. Good goes around.

Promoting green spaces in our facilities.

Our manufacturing facility in Colombia sits on a campus that invested heavily in adding trees and green spaces where there weren't any before, for improved carbon offset. Our new corporate headquarters that will open in 2025, is designed as a multi-use space with large green areas both indoors and outdoors that are designed as flexible work spaces both for us and open to the public.

Creating a paperless company

From our beginnings over 25 years ago, we envisioned a nature-centric company that would use technology to remain paperless. We have no file cabinets, and our team members work together on multiple, energy-efficient screens, integrating electronically with our vendors and customers. We continue to pioneer ways to work more resource-efficiently throughout.



DESIGN & PRODUCTION

- Responsible manufacturing is fundamental: efficient, safe, environment-conscious, and community-minded.
- Total Recycling approach reusing scrap and excess in our own facilities.
- Use of local, renewable suppliers when available.



100% MATERIALS

- Designed for continuous use – never ending the lifecycle.
- 100% recyclable across multiple lifecycles.
- Easily separated mixed materials.
- **Introducing** upcycled and bio-based innovations: **Circular Positive™** product ranges.



DISTRIBUTION

- Lightweight and unbreakable products that use less energy and packaging in transport.
- Ordering, production and shipping procedures to minimize resource consumption.



CONSUMER EXPERIENCE

- Using less water and fertilizer, a vital element in sustainable gardens.
- TruDrop self-watering planters collect rain and irrigation water for up to 50% savings.
- High durability. Most products supported by a 10 Yr Warranty.

Specifications on Product

dimensions		
7.75 in 19.7 cm	11.75 in 29.8 cm	11.00 in 27.9 cm

We have included inner and outer measurements as well as volume capacity for all our planters to make it easy when specifying a planter for a job.

	dimensions				volume capacity	planter ref.#	saucer ref.#
A Agave 18" Planter	12.75 in 34.3 cm	7.75 in 19.7 cm	11.75 in 29.8 cm	11.00 in 27.9 cm	4.50 gal 15.8 l	A8800XX	A80000T
B Agave 18" Planter	17.75 in 45.1	18.25 in 46.3	13.00 in 33.0	13.50 in 34.3	9.00 gal 34.1	A8800XX	A80000T
Agave 24" Planter	23.75 in 60.3	12.25 in 31.1	18.00 in 45.7	17.25 in 43.8	13.50 gal 51.1	A8800XX	A80000T

Identify the Logos



See the next page for more details.

Quick Ship



In-Stock colors and ready to ship.



CRESCENT garden

87

Product Brand Identity

CRESCENT
garden

Crescent**TOO**

Identify the Logos

10 Year
Limited
Warranty

10 Year Warranty

Our 10 Year Warranty against fading, or cracking on our rotationally molded products gives confidence to consumers when purchasing our products.



Circular Positive™, **NEW!**

A circular, continuous approach for plant and planet: these planters are manufactured with an upcycled material made from landfill waste diverting harmful emissions for a more positive environmental impact.



TruDrop System

Our patented TruDrop self-watering delivers phenomenal results with little effort. See more details on page 18



Water Gardening

Easy to install and maintain, these containers are ideal to tap into the water gardening market. With a broad selection of shapes, depths and sizes, these containers can accommodate a variety of water gardening plants and fish. Some of our planters are also supplied with specialty plugs to use with fountain pumps.



No Drainage Holes

Healthy plants start with proper drainage. We design most of our planters with elevated pot feet and drainage holes that are adequately sized for each planter. However, there are times when consumers just need a cache pot or drainage can be an issue. In these case you will find the No Drainage Holes icon on the page.



Double Wall

Double Walled construction provides many benefits including superior structural integrity, enhanced appearance and insulating properties for better thermal protection of plant roots.



Can be Personalized

Some of our planters can be branded with a logo, house number or family name. See page 14.



Custom Color

Provide us with a Pantone color choice of your own and we can have the product manufactured specifically for your design needs.



HF Water Reservoir

This traditional self-watering system includes lava rocks to place at the bottom of the planter to create a small reservoir to extend between watering.



CRESCENT
garden

HF



HF System

This great selection of planters comes with the HF self-watering system for easy maintenance and healthier plants.

Diversity of Materials

From stainless steel, to wood and leather, these planters offer rich texture to match any environment both indoors and outdoors.



Custom Color

There is an endless possibility of color options as these planters can be customized for individual projects. Just contact our customer service for more information.

5 Year Limited Warranty

The materials and manufacturing of these products represent quality craftsmanship. The metals are forged from thick rolled materials making sure they are resistant. The wood veneers are selected for their uniformity in color.



Self-Watering System

Built in with a **reservoir**, wicks and volcanic rock, the HF planters have a traditional self-watering system that functions well indoors.

Variety of Finishes

The richness of **leather**, the industrial feel of perforated **metals**, or the refined **gloss** allows you to match style to your curated design.





5 Year Limited Warranty

Fabricated with quality products, these planters are made to withstand commercial traffic.



Custom Color Choice

Thinking ahead to your next project. These planters can be customized in any pantone color your design requires.





High Gloss:

As shiny as your patent leather shoes, these planters will add stature to any interior environment.



Elegant and Minimalist:
These planters bring a classic touch
to any commercial setting.



Bring plants to Eye Level:
With our tall Ferrum planters you can make
sure your plants are the focal point.



Natural Ash Wood:

Our new Fuse planters blend the soft feel of wood with metal finishes to give your plants the luxury statement they deserve.

HF System

The HF patented self-watering system was first developed in Europe. These planters are manufactured with premium quality materials and ideal for both residential and commercial properties.

The self-watering system was designed for minimum watering. For indoor applications tank only needs to be filled 4 times a year and surface water introduced every 4 to 5 weeks. Watering will obviously vary on plant variety and air temperatures.

This system works to maintain plants healthier by increasing the circulation of oxygen to both water and roots.

- Patented System
- Easy to Maintain
- Uses less water
- Certified by the Spanish Department of Plant Physiology
- Certified by the Spanish Society of Horticulture

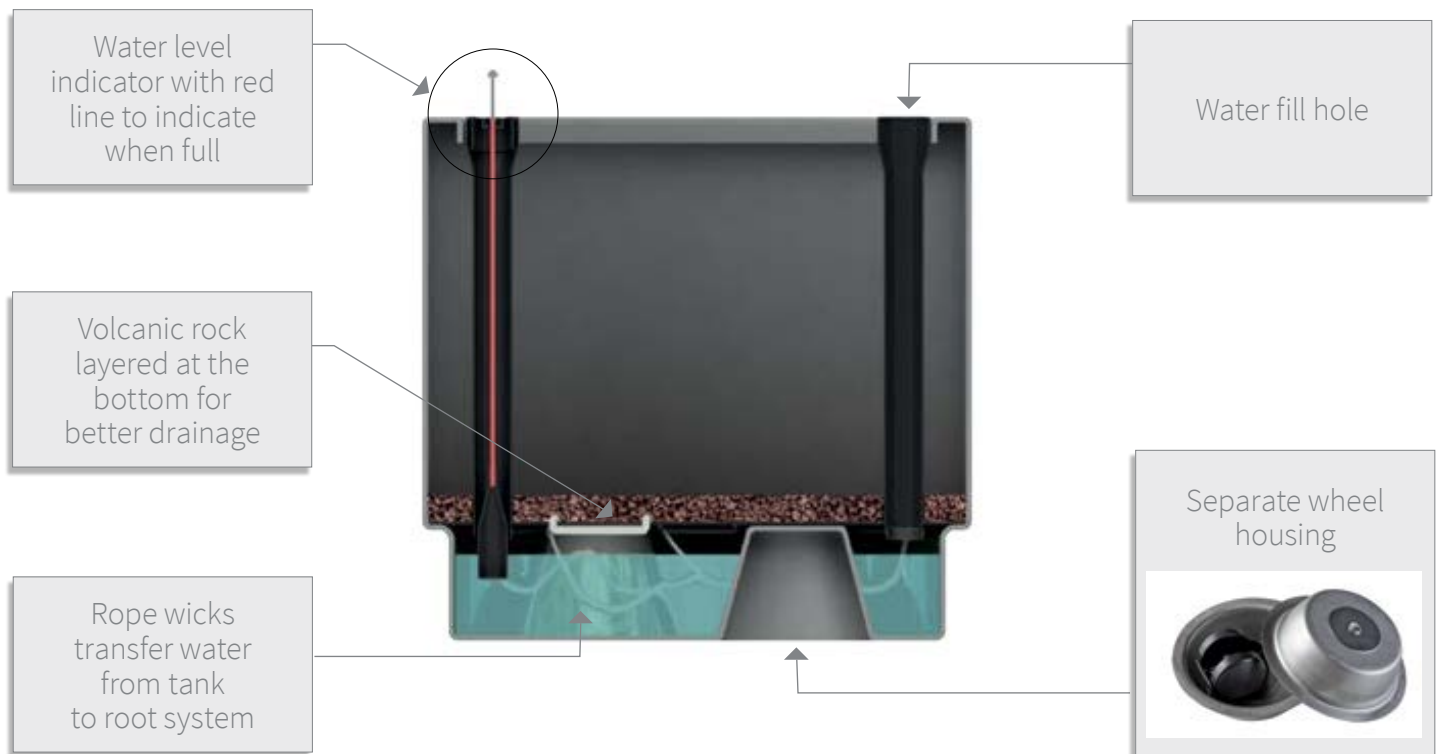

1

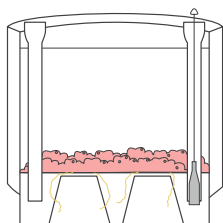

Each planter includes a bag of hydro rocks which should be layered at the bottom before planting. These rocks are porous and will absorb water, maintaining moisture near the plant's root system.

2

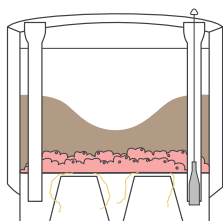

Rocks should be covered with a potting mix selected to complement your plant choice.

3

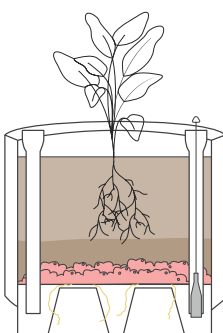

Plant should then be potted making sure to delicately separate roots.

4

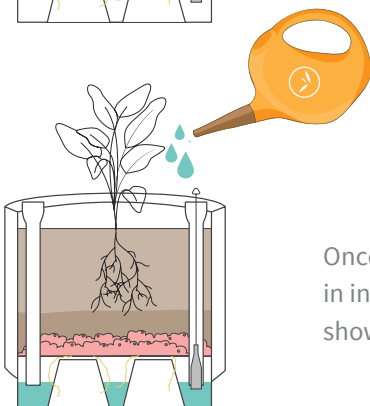

Once planted, container should be watered slowly and in intervals, from the top until the water level indicator shows red for full.

5

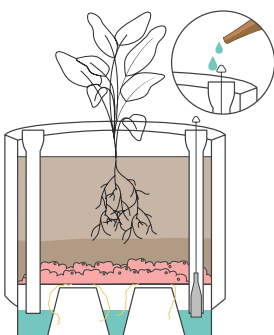

Maintenance is easy. Fill the tank only 4 times a year and surface water every 4 or 5 weeks.

If using outdoors where planters will receive rain water please consult with us before hand to instruct on how to add an overflow drain.

Ferrum Perforated Planters

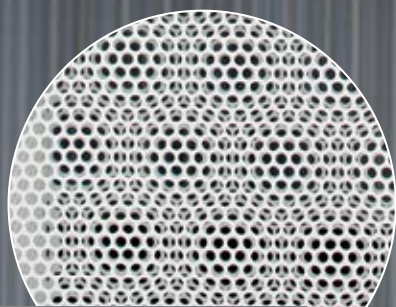

Texture Detail



White

		dimensions				volume capacity		planter ref.#
		soil		water				
A	Ferrum 15" Perforated Square Planter*	15.0 in 38,1 cm	15.0 in 38,1 cm	13.8 in 35,1 cm	11.2 x 11.2 in 28,4 x 28,4 cm	6.34 gal 24,0 l	1.06 gal 4,01 l	AZ7015XX
B	Ferrum 15" Perforated Tall Square Planter	15.0 38,1	15.0 38,1	35.4 89,9	11.2 x 11.2 28,4 x 28,4	6.34 24,0	1.06 4,01	AZ7115XX

* Casters available for this planter. See page 42 for more information.



Custom Color Choice
PANTONE

IN-STOCK QUICK SHIP COLORS

TREATED STAINLESS STEEL - Great for outdoor use, these planters have been treated to withstand weathering.



Textured White Ref: 01



Lead Ref: 92



Corten Steel Ref: 33

Ferrum Rectangular and Tall Planters



Texture Detail



		dimensions				volume capacity		planter ref.#
		soil	water					
A	Ferrum 43" x 16" Rectangular Planter*	43.3 in 110,0 cm	15.7 in 39,9 cm	15.7 in 39,9 cm	39.4x12.6 in 100,1x32,0 cm	30.12 gal 114,01 l	6.60 gal 24,98 l	AZ5868XX
B	Ferrum 39" x 10" Rectangular Planter	39.4 100,1	9.8 24,9	29.5 74,9	36.2 x 7.5 91,9 x 19,1	12.94 48,98	3.70 14,01	AZ5839XX
C	Ferrum 39" x 10" Low Rect. Planter**	39.4 100,1	9.8 24,9	13.8 35,1	36.2 x 7.5 91,9 x 19,1	12.94 48,98	3.70 14,01	AZ5840XX
D	Ferrum 14" Tall Square Planter	13.8 35,1	13.8 35,1	35.4 89,9	11.2 x 11.2 28,5 x 28,5	6.34 24,00	1.60 6,06	AZ5914XX

* Casters available for this planter. See page 42 for more information.



Custom
Color Choice
PANTONE

IN-STOCK QUICK SHIP COLORS

PAINTED STAINLESS STEEL



Taupe Ref: 81



White Ref: 01

TREATED STAINLESS STEEL - Great for outdoor use, these planters have been treated to withstand weathering.



Corten Steel Ref: 33



Lead Ref: 92





Ferrum Round Planters



Texture Detail



White

		dimensions			volume capacity		planter ref.#
					soil	water	
A	Ferrum 16" Round Planter*	16.5 in 41,9 cm	15.7 in 39,9 cm	14.2 in 36,1 cm	10.04 gal 38,01 l	1.32 gal 5.00 l	AZ5616XX
B	Ferrum 20" Round Planter*	19.7 in 50,0 cm	15.7 in 39,9 cm	16.1 in 40,9 cm	12.94 gal 48,98 l	2.11 gal 7.99 l	AZ5620XX
C	Ferrum 24" Round Planter*	23.6 in 59,9 cm	19.7 in 50,0 cm	20.9 in 53,1 cm	19.28 gal 72,98 l	2.91 gal 11.02 l	AZ5624XX

* Casters available for this planter. See page 42 for more information.



Custom
Color Choice
PANTONE

IN-STOCK QUICK SHIP COLORS

PAINTED STAINLESS STEEL



Taupé Ref: 81







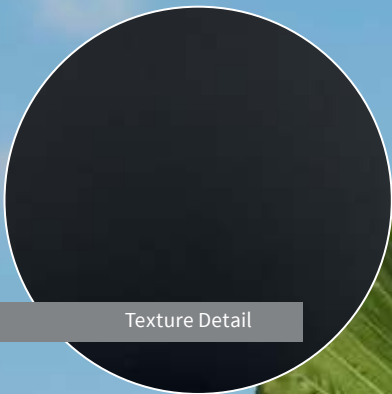



White Ref: 01

Ferrum Square Planters



Texture Detail



 A B		dimensions				volume capacity		planter ref.#
		soil		water				
								
A	Ferrum 20" Square Planter*	19.7 in 50,0 cm	19.7 in 50,0 cm	15.7 in 39,9 cm	16.7 x 16.7 in 42,4 x 42,4 cm	16.38 gal 41,61 l	3.17 gal 12,00 l	AZ5720XX
B	Ferrum 30" Square Planter*	29.5 74,9	29.5 74,9	15.7 39,9	26.4 x 26.4 67,1 x 67,1	39.89 101,3	8.45 31,99	AZ5730XX

* Casters available for this planter. See page 42 for more information.



Custom
Color Choice
PANTONE

IN-STOCK QUICK SHIP COLORS

PAINTED STAINLESS STEEL



Taupe Ref: 81



White Ref: 01

TREATED STAINLESS STEEL - Great for outdoor use, these planters have been treated to withstand weathering.



Lead Ref: 92



Corten Steel Ref: 33

Fuse Family of Planters and Furniture





Fuse Planters



Texture Detail

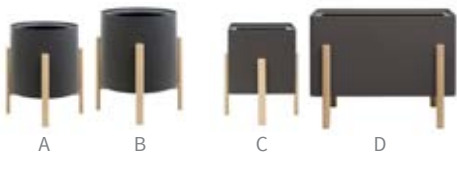

Warm Grey/Ash Legs

		dimensions				volume capacity		planter ref.#
		soil		water				
A	Fuse 16" Planter	16.1 in 40,9 cm	16.1 in 40,9 cm	20.1 in 51,1 cm	13.8 x 13.8 in 35,1 x 35,1 cm	4.76 gal 18,02 l	0.79 gal 2,99 l	AZ7441XX
B	Fuse 19" Planter	18.9 48,0	18.9 48,0	22.8 57,9	16.5 x 16.5 41,9 x 41,9	10.04 38,01	1.32 5,00	AZ7448XX
C	Fuse 16" Square Planter	16.1 40,9	16.1 40,9	20.1 51,1	13.8 x 13.8 35,1 x 35,1	6.34 24,00	1.06 4,01	AZ7517XX
D	Fuse 30" x 16" Rectangular Planter	29.9 75,9	16.1 40,9	22.8 57,9	29.5 x 13.8 in 74,9 x 35,1	17.17 65,00	3.43 12,98	AZ7631XX



Custom Color Choice PANTONE

IN-STOCK QUICK SHIP COLORS



Lead/Ash Legs Ref: 92

12 WEEK LEAD TIME



White/Ash Legs Ref: 01



Warm Grey/Ash Legs Ref: 84



Bordeaux/Ash Legs Ref: 47

Fuse Furniture

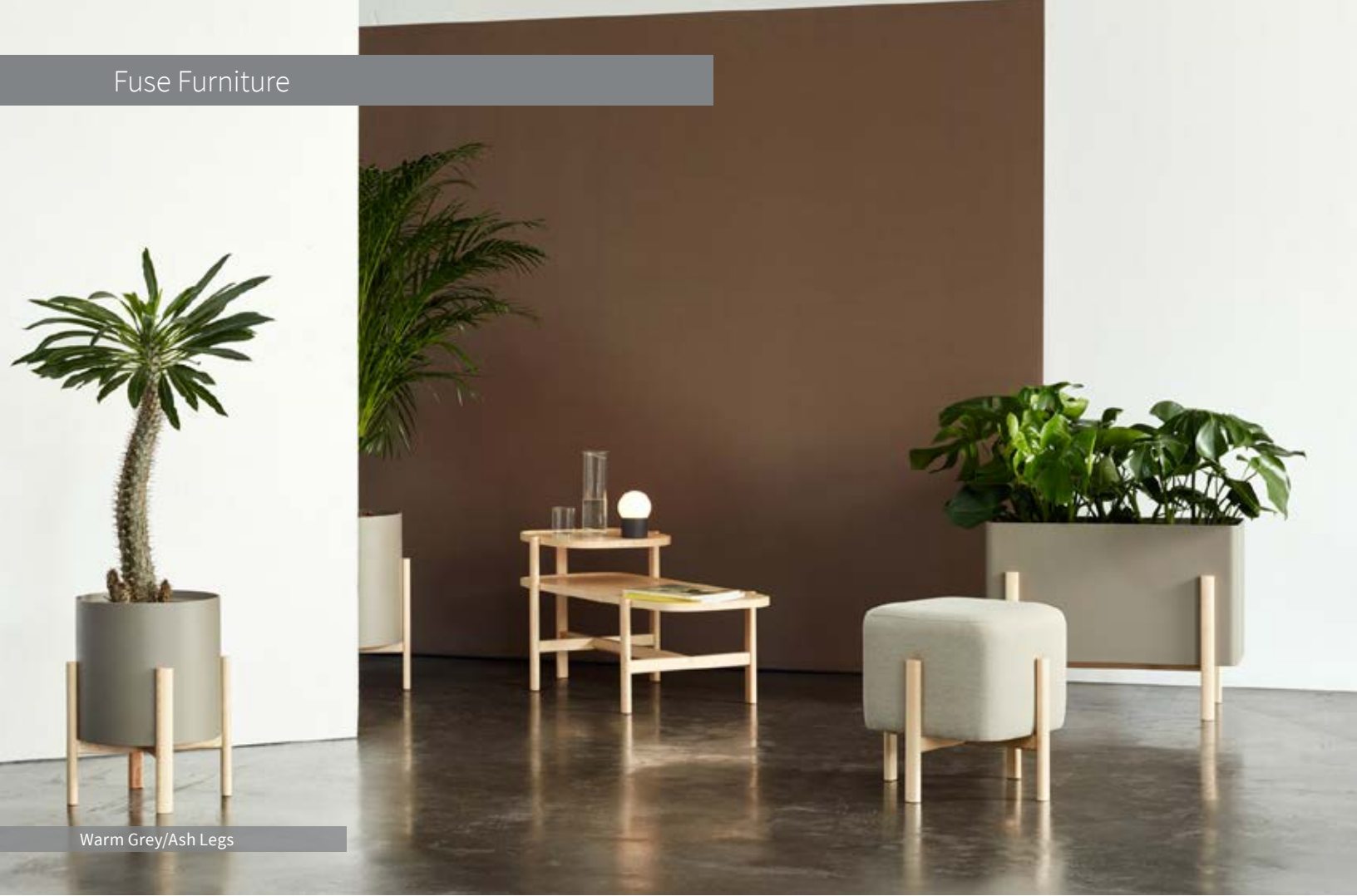





Warm Grey/Ash Legs



Cool Grey/Ash Legs



		dimensions			product ref.#			
								
A	Fuse 40" x 19" Upholestered Bench	39.8 101,1	in cm	18.9 48,0	in cm	18.5 47,0	in cm	AZ7748XX
B	Fuse 19" Upholestered Backless Seat	18.9 48,0		18.9 48,0		18.5 47,0		AZ7723XX
C	Fuse 40" x 19" Table (Natural Ash)	39.8 101,1		18.9 48,0		19.7 50,0		AZ784813
D	Fuse 19" Square Table (Natural Ash)	18.9 48,0		18.9 48,0		19.7 50,0		AZ782313

IN-STOCK QUICK SHIP COLORS



Cool Grey/Ash Legs Ref: 91



Natural Ash

12 WEEK LEAD TIME



Dusty Mauve/Ash Legs Ref: 48



Bordeaux/Ash Legs Ref: 47



Warm Grey/Ash Legs Ref: 84

Lin Planters



Texture Detail



White

		dimensions				volume capacity		planter ref.#
						soil	water	
A	Lin 18" Square Planter	17.7 in 45,0 cm	17.3 in 43,9 cm	17.7 in 45,0 cm	11.2 in 28,4 cm	6.34 gal 24,00 l	1.06 gal 4,01 l	AZ7218XX
B	Lin 18" Tall Square Planter	17.7 45,0	17.3 43,9	35.4 89,9	11.2 28,4	6.34 24,00	1.06 4,01	AZ7318XX
C	Lin 43" x 14" Rectangular Planter	43.3 110,0	13.8 35,1	19.7 50,0	39.4 x 9.8 100,1 x 24,9	30.12 114,02	6.60 24,98	AZ7259XX



Custom
Color Choice
PANTONE

IN-STOCK QUICK SHIP COLORS

TREATED STAINLESS STEEL - Great for outdoor use, these planters have been treated to withstand weathering.



Textured White Ref: 01



Lead Ref: 92





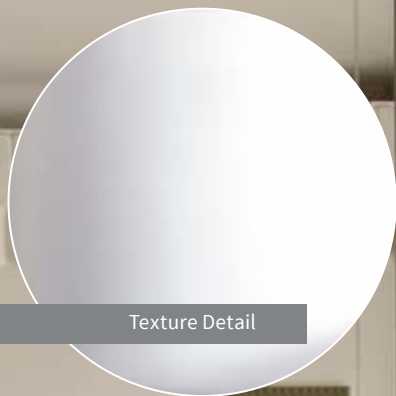

Corten Steel Ref: 33

Lux Planters



Texture Detail



 A B		dimensions			volume capacity		planter ref.#
					soil	water	
A	Lux 21" Planter*	21.3 in 54,1 cm	16.5 in 41,9 cm	13.6 in 34,5 cm	12.94 gal 48,98 l	2.11 gal 8,00 l	AZ5021XX
B	Lux 25" Planter*	24.8 63,0	16.5 41,9	N/A N/A	N/A N/A	N/A N/A	AZ5025XX

* Casters available for this planter. See page 42 for more information.



IN-STOCK QUICK SHIP COLORS



White Ref: 01



Red Ref: 30



Chartreuse Ref: 60



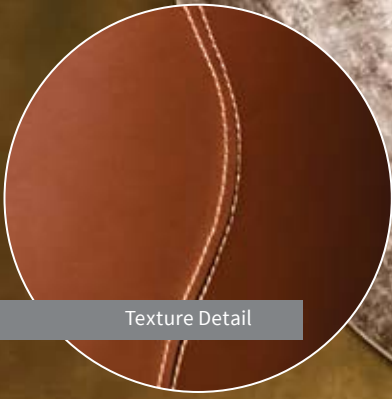





Taurus Planters



Texture Detail



Brown Leather

 A  B		dimensions				volume capacity		planter ref.#
		soil		water				
								
A	Taurus 21" Planter*	20.9 in 53,1 cm	20.9 in 53,1 cm	16.5 in 41,9 cm	15.6 x 15.6 in 39,6 x 39,6 cm	12.94 gal 48,98 l	2.11 gal 8,00 l	AZ5421XX
B	Taurus 21" Square Planter	21.3 in 54,1 cm	21.3 in 54,1 cm	16.5 in 41,9 cm	16.7 x 16.7 in 42,4 x 42,4 cm	16.38 gal 62,01 l	3.17 gal 12,00 l	AZ5521XX

* Casters available for this planter. See page 42 for more information.



IN-STOCK QUICK SHIP COLORS



Brown Leather Ref: 31

Accessory Replacements For HF





A



B C D

description		product ref.#
A	Casters for HF System	AZR01
B	Small Water Gauge HF System for 14" (35 cm) Height	AZ601488
C	Medium Water Gauge HF System for 16" (40 cm) Height	AZ601688
D	Large Water Gauge HF System for 20" (50 cm) Height	AZ602088

Recommended caster qty and gauge size for HF planter style _____

planter ref.#	description	number of casters needed	size of water gauge
AZ7015	Ferrum 15" Square Planter Perforated	4	Small
AZ7115	Ferrum 15" Tall Square Planter Perforated	N/A	Large
AZ5868	Ferrum 43" x 16" Rectangular Planter	5	Medium
AZ5839	Ferrum 39" x 10" Rectangular Planter	N/A	Large
AZ5840	Ferrum 39" x 10" Low Rectangular Planter	N/A	Small
AZ5914	Ferrum 14" Tall Square Planter	N/A	Large
AZ5616	Ferrum 16" Round Planter	4	Medium
AZ5620	Ferrum 20" Round Planter	4	Medium
AZ5624	Ferrum 24" Round Planter	5	Large
AZ5720	Ferrum 20" Square Planter	4	Medium
AZ5730	Ferrum 30" Square Planter	5	Medium
AZ7441	Fuse 16" Planter (White/Ash Legs)	N/A	Large
AZ7448	Fuse 19" Planter (White/Ash Legs)	N/A	Large
AZ7517	Fuse 16" Square Planter (White/Ash Legs)	N/A	Large
AZ7631	Fuse 30 x 16" Rectangular Planter (White/Ash Legs)	N/A	Large
AZ7218	Lin 17" Square Planter (White)	N/A	Medium
AZ7318	Lin 17" Tall Square Planter (White)	N/A	Large
AZ7259	Lin 43" x 14" Rectangular Planter (White)	N/A	Large
AZ5021	Lux 21" Planter	4	Medium
AZ5025	Lux 25" Planter	4	Medium
AZ5421	Taurus 21" Planter	4	Medium
AZ5521	Taurus 21" Square Planter (Brown Leather)	N/A	Medium

Quick Ship Program and Special Orders

We provide a wide array of in stock items in our Quick Ship program that are readily available all year round. We consider these to be a selection of our best selling colors in each design and style. These can be viewed throughout the catalog in the individual shots provided on each page.

However, all of our Crescent Garden planters can also be customized in any of the colors below. Check with your customer service representative for lead times, pricing and terms on special orders.

Standard Colors:

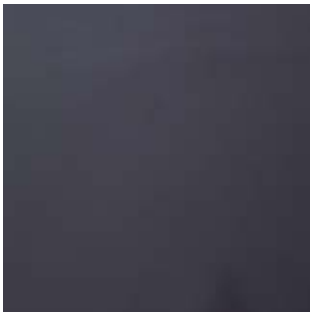

Caviar Black Ref: 94



Old Bronze Ref: 14



Mocha Ref: 44

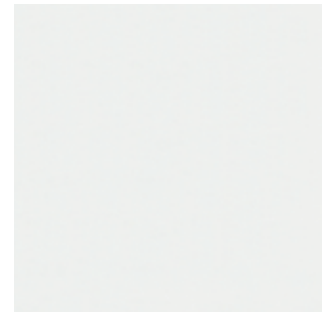

Cloud White Ref: 00



Rust Ref: 33



Weathered Terracotta Ref: 34



Weathered Concrete Ref: 92



Midnight Ref: 55



Olive Ref: 82

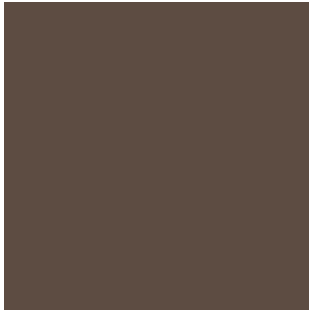

Bark Ref: 74



Currant Ref: 47



Ash Ref: 98



Slate Ref: 97



Parchment Ref: 11



Shadow Ref: 95

Can be Personalized

Make your next project unique by customizing the planters.

- Brand with hotel, city, healthcare facility or park name to delineate campuses and create greater awareness.
- Use for residential properties to identify street or house numbers.
- Create a custom family crest or display a family name to give an entrance a special touch.

Available Styles for Personalization



Pinch Planter



Rim Planter

Let's get started:

Image Requirements:

Vectorized graphic should be provided in any of the following file types: .ai, .eps, .dxf or .pdf. If providing pdf it should be created from a vectorized graphic.

Timeline for Customized Project:

Once images are received, we would provide artwork for approval within 4-5 working days. We would require signature approval on artwork. Once this is returned to us production lead time for Quick Ship items, can be between 4-5 weeks.

Minimums:

Contact us at customerservice@crescentgarden.com, for details on minimums and pricing for customized projects.







 TruDrop ONE



Weeks without Watering

With our TruDrop self-watering, containers can go without watering for 2-6 weeks depending on plant selection and climate.

Easy

With no rocks or wicks, this single-body planter just needs potting soil and plant making it easy even for first time gardeners.



Safe, Efficient

With 50% less water usage and more efficient use of fertilizers that remain in the water cavity, these planters are environmentally friendly.

Dramatically Successful

In our planters with TruDrop the plants determine how much water they need instead of the consumer which renders phenomenal results.

CRESCENT
garden

TruDrop ONE

Finally.
A planter that
works for you.



Easy



Safe



Success



Efficient



Versatile



Water Level Indicator

Easy to read.

Easy To Fill Hole

Includes cap to avoid water contamination.

Double Wall Construction*

Large water reservoir allows plants to go longer without watering.

Mess Free Drain System

Optional quick connect coupling in larger planters facilitates draining planter without spillage.

Can connect directly to hose or pump.



Overfill Drain

When using outdoors, planter is designed to drain excess rain water.

Sealed Bottom

Plug included with planter for indoor use.

Capillary Action

Watering via roots creates healthy plants.



*Outdoor trials using a 20" (50,8 cm) planter have shown that plants **can go for up to 6 weeks without refilling.**

We never expected TruDropOne to change the way people garden but now we hear it from our clients.

“

“I returned home from **two weeks’ vacation...** and was very happy to see that my TruDrop planter did its job while I was away.”

Jed Laufferty, West Chester, Pennsylvania, U.S.A



“

“I think these are the **best** things since sliced bread lol.”

Jed Susan, Ontario, Canada

“

“They work great for me, as we live at a **lake home** with 6 outdoor pots and we are gone from our home several times a month for anywhere from a couple days to a week. With your pots, my flowers now make it through the summer without dying from lack of water.”

Debbie, Minnesota, U.S.A

“

“TruDrop’s claims that watering is only needed every two to six weeks sounded a little far-fetched, but... (It) works better than I ever imagined.”

Heather Rhoades, **Gardening Know How**

“

I got 26 days out of it... I **saved** that much **time** watering!

Laura LeBoutillier, **Garden Answer**, Oregon, U.S.A



“

“The pottery is **gorgeous** by the way! We have one very happy customer - can't wait to order more!”

Erin, **Landscape Solutions Company**, Tennessee, U.S.A



“

"We are a Boutique Resort in beautiful St. Croix, US Virgin Islands. For years we have searched for planters which could withstand our sun and sea elements and still have a classy and elegant presence. The planters are very easy to set up, plant and maintain. The guests continually compliment the elegance and beauty. We can not say enough about the quality of product and customer service."

Sand Castle on the Beach Hotel, Virgin Islands, U.S.A.

“

"Where we were once watering every day, we are now able to simply "top off" each planter once a week. The savings in man power have been exponential."

Mark Russel (Director of Horticulture),
SeaWorld Parks and Entertainment
Orlando, U.S.A.



“

"They have sixteen Pinch in Lawrence. I wouldn't use anything else now for city planters it saves me a lot of watering time! I have 34 estate planters in the city next to Lawrence, Haverhill. I have to water those every third day. Not with the Pinch."

Steve Nunan - Massachussetts
Nunan's Florist and Greenhouse, U.S.A.



Crescent Garden: Design Ideas



Edibles in Small Spaces:
Our Nest planters are ideal to grow edibles even in spaces with no garden.



Step it up:
With the 14" width Mod planters it is easy to bring green to narrow spaces.



Midnight Blue:

A great replacement for black, Midnight will add elegance to any space.

Crescent Garden: Design Ideas



Commercial Applications:

With TruDrop a commercial space can be retrofitted with new planters without the investment of costly sub-irrigation installations.



RESTAURANT & BAR



Narrow and Tall:
Instead of traditional urns these curved Cup planters make elegant entryways.



Supersize:

When you have a door that is over 7 feet tall make sure you use a planter proportionate like the Rim 30".



Better Economics:

TruDrop self-watering allows properties to maintain planters at a fraction of the regular cost giving them flexibility to add green in more places.

Cup Tall Planters

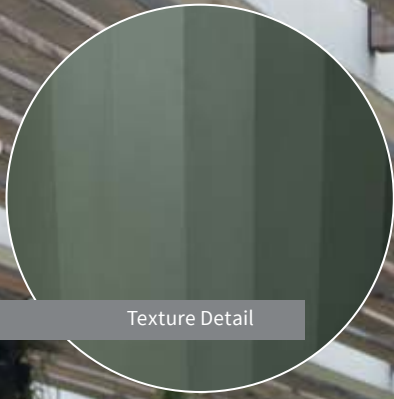

Texture Detail



Bark and Olive

		dimensions				volume capacity		planter ref.#	saucer ref.#
		soil	water	soil	water				
A	Cup Tall 16" Planter	15.75 in 40,0 cm	9.61 in 24,4 cm	11.58 / 11.02 in 29,4 / 28,4 cm	29.53 in 75,0 cm	6.16 gal 23,3 l	3.17 gal 12,0 l	A6440XX	A9910XXT
B	Cup Tall 19" Planter	18.70 47,5	11.22 28,5	14.53 / 14.96 36,9 / 38,0	34.65 88,0	11.29 42,7	5.65 21,4	A6447XX	A9913XXT
C	Cup Tall 22" Planter	21.65 55,0	12.99 33,0	17.48 / 19.23 44,4 / 48,8	39.37 100,0	19.15 72,5	8.32 31,5	A6455XX	A9915XXT

Make sure to order mess-free drain couplings if you will be emptying water cavity on a delicate surface. See page 95.



IN-STOCK QUICK SHIP COLORS



Caviar Black Ref: 94



Cloud White Ref: 00



Ash Ref: 98



Slate Ref: 97



Midnight Ref: 55



Olive Ref: 82



Bark Ref: 74

* 10 Year Limited Warranty covers planter shell only.

Dot Planters



Texture Detail



Cloud White

		dimensions				volume capacity		planter ref.#	saucer ref.#
						soil	water		
A	Dot 16" Planter**	16.00 in 40,6 cm	9.80 in 24,9 cm	12.80 / 6.90 in 32,5 / 17,5 cm	16.00 in 40,6 cm	3.59 gal 13,6 l	2.14 gal 8,1 l	A5940XX	A9910XXT
B	Dot 20" Planter	20.00 50,8	12.28 31,2	16.21 / 9.45 41,2 / 24,0	20.04 50,9	7.36 27,9	5.42 20,5	A5950XX	A9913XXT
C	Dot 26" Planter	26.00 66,0	15.96 40,5	22.21 / 12.00 56,4 / 30,5	26.04 66,1	19.59 74,2	12.8 48,5	A5965XX	A9918XXT

Make sure to order mess-free drain couplings if you will be emptying water cavity on a delicate surface. See page 95.



IN-STOCK QUICK SHIP COLORS



Old Bronze Ref: 14



Caviar Black Ref: 94



Cloud White Ref: 00



Mocha Ref: 44



Midnight Ref: 55



Ash Ref: 98



Slate Ref: 97

* 10 Year Limited Warranty covers planter shell only.

** This size does not include a side drain and cannot accommodate a mess free drainage system.

Mod Family of Planters





Mod Family of Planters

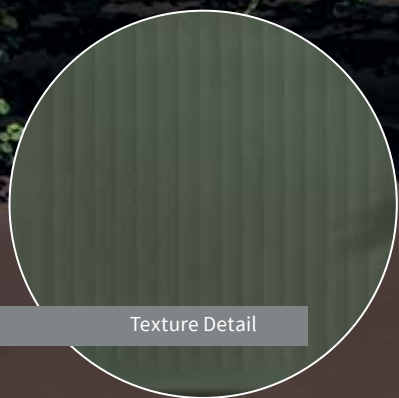

Texture Detail

RESTAURANT & BAR



Cloud White, Ash and Olive

Planters in 20" (51 cm) width Planters in 14" (36 cm) width		dimensions			volume capacity		planter ref.#
					soil	water	
A	Mod Low Square 20" x 20" x 16"H	19.7 x 19.7 in 50,0 x 50,0 cm	14.96 x 15.35 / 14.76 in 38,0 x 39,0 / 37,5 cm	15.75 in 40,0 cm	8.85 gal 33,5 l	7.93 gal 30,0 l	A6140XX
B	Mod Large Trough 40" x 20" x 20"H	39.3 x 19.7 99,8 x 50,0	35.04 x 15.75 / 18.70 89,0 x 40,0 / 47,5	19.69 50,0	26.95 102,0	19.55 74,0	A6150XX
C	Mod Tall Square 20" x 20" x 38"H	19.7 x 19.7 50,0 x 50,0	14.96 x 14.96 / 37.40 38,0 x 38,0 / 95,0	38.19 97,0	19.55 74,0	15.85 60,0	A6197XX
D	Mod 20" Tall and Narrow 20" x 14" x 24"H	19.7 x 13.8 50,0 x 35,1	14.96 x 9.06 / 16.34 38,0 x 23,0 / 41,5	23.62 60,0	5.34 20,2	12.63 47,8	A6160XX
E	Mod 40" Tall and Narrow 40" x 14" x 30"H	39.3 x 13.8 99,8 x 35,1	33.07 x 9.06 / 28.35 84,0 x 23,0 / 72,0	29.53 75,0	22.72 86,0	19.94 75,5	A6175XX
F	Mod Mini Trough 20" x 14" x 12"H **	19.7 x 13.8 50,0 x 35,1	14.96 x 9.06 / 11.02 38,0 x 23,0 / 28,0	11.81 30,0	4.20 15,9	3.34 12,6	A6130XX

Make sure to order mess-free drain couplings if you will be emptying water cavity on a delicate surface. See page 95.

*



IN-STOCK QUICK SHIP COLORS



Caviar Black Ref: 94



Cloud White Ref: 00



Ash Ref: 98



Slate Ref: 97



Midnight Ref: 55



Olive Ref: 82



Bark Ref: 74

* 10 Year Limited Warranty covers planter shell only.

** This size does not include a side drain and cannot accommodate a mess free drainage system.

Six different sizes.
Move them, stack them,
and create your own space.



Mod planters in 20 in (51 cm) width



Mod planters in 14 in (36 cm) width

Mod planters maximum stack is 2 planters only.



Mod planters with 20 in (51 cm) width



Mod Low Square

20" x 20" x 16"H

A6140XX

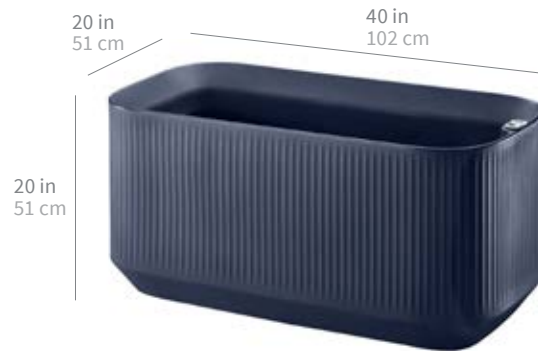

Mod Large Trough

40" x 20" x 20"H

A6150XX



Mod Tall Square

20" x 20" x 38"H

A6197XX

Mod planters with 14 in (36 cm) width

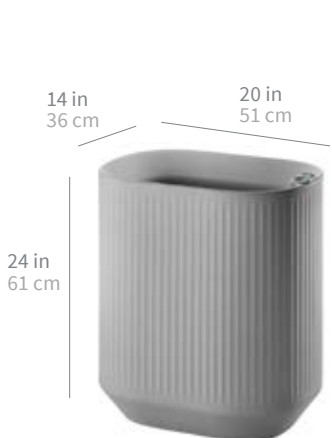

Mod 20" Tall and Narrow

20" x 14" x 24"H

A6160XX

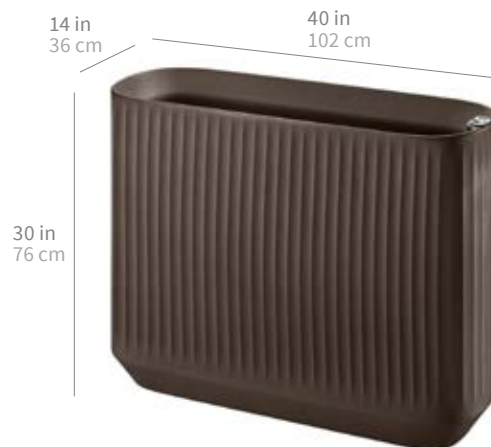

Mod 40" Tall and Narrow

40" x 14" x 30"H

A6175XX

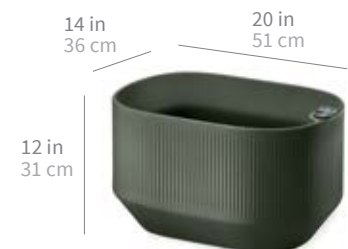

Mod Mini Trough

20" x 14" x 12"H

A6130XX

Nest Planters



Cloud White



Cloud White



Cloud White



Bark



Slate and Olive in back

Nest Planters



Texture Detail



Slate and Olive in back

		dimensions			soil volume capacity	water volume capacity	planter ref.#
A	Nest 18" x 36" Raised Planter	18.00 x 36.00 in 45,7 x 91,4 cm	13.03 x 31.34 / 9.05 in 33,1 x 79,6 / 23,0 cm	16.00 in 40,6 cm	13.21 gal 50,0 l	6.67 gal 25,2 l	A6249XX
B	Nest 22" x 44" Raised Planter	22.00 x 44.00 55,9 x 111,8	17.22 x 39.27 / 9.05 43,7 x 99,7 / 23,0	16.00 in 40,6	22.80 86,3	12.25 46,4	A6251XX
C	Nest 30" x 48" Raised Planter	30.00 x 48.00 76,2 x 121,9	25.24 x 42.96 / 9.06 64,1 x 109,1 / 23,0	16.00 in 40,6	40.15 152,0	18.49 70,0	A6271XX

Make sure to order mess-free drain couplings if you will be emptying water cavity on a delicate surface. See page 95.

Nest Height with Legs			
A, B, C	20.00 in 50,8 cm	36.00 in 91,4 cm	



IN-STOCK QUICK SHIP COLORS



Cloud White Ref: 00



Weathered Terracotta Ref: 34



Slate Ref: 97



Midnight Ref: 55



Olive Ref: 82



Bark Ref: 74

* 10 Year Limited Warranty covers planter shell only.



		dimensions				product ref.#
		Width		Height		
A	Trellis for 18" Nest Raised Planter	17.60 44,7	in cm	28.00 71,1	in cm	AZ631894
	Trellis for 22" Nest Raised Planter	22.00 55,9		28.00 71,1		AZ632294
	Trellis for 30" Nest Raised Planter	29.80 75,7		28.00 71,1		AZ633094
B	Greenhouse Cover for 18" Nest Raised Planter (includes storage bag)	18.20 x 36.50 46,2 x 92,7		26.40 67,1		AZ641800
	Greenhouse Cover for 22" Nest Raised Planter (includes storage bag)	22.70 x 44.70 57,7 x 113,5		26.40 67,1		AZ642200
	Greenhouse Cover for 30" Nest Raised Planter (includes storage bag)	30.50 x 48.20 77,5 x 122,4		26.40 67,1		AZ643000
C	Hooks for Nest Raised Planter (Bag of 2)	3.00 7,6		3.50 8,9		AZ670094C

A - Trellis for Nest Raised Planter



B - Greenhouse Cover for Nest Raised Planter



C - Hook for Nest Raised Planter



Pinch Planters







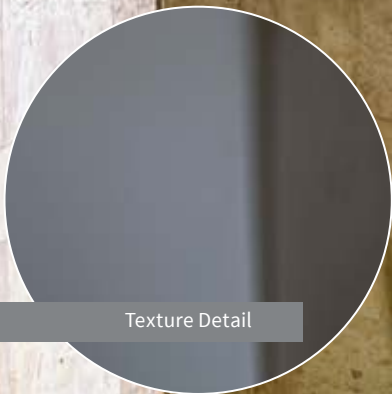



Pinch Planters

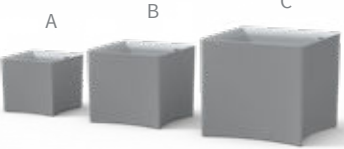

Texture Detail



Slate

		dimensions			soil volume capacity	water volume capacity	planter ref.#
							
A	Pinch 23" Planter	22.52 in 57,2 cm	21.85 x 19.69 / 10.04 in 55,5 x 50,5 / 25,2 cm	20.28 in 51,5 cm	11.73 gal 44,4 l	9.91 gal 37,5 l	A6757XX
B	Pinch 29" Planter	28.98 73,6	28.35 x 26.38 / 12.60 72,0 x 67,0 / 32,0	26.06 66,2	26.95 102,0	24.57 93,0	A6774XX
C	Pinch 37" Planter	36.93 93,8	36.30 x 34.65 / 15.75 92,2 x 88,0 / 40,0	33.27 84,5	60.76 230,0	55.48 210,0	A6794XX

Make sure to order mess-free drain couplings if you will be emptying water cavity on a delicate surface. See page 95.



IN-STOCK QUICK SHIP COLORS



Caviar Black Ref: 94



Cloud White Ref: 00



Ash Ref: 98



Slate Ref: 97



Midnight Ref: 55



Olive Ref: 82



Bark Ref: 74

* 10 Year Limited Warranty covers planter shell only.

Rim Planters













Rim Planters



Texture Detail



		dimensions				soil volume capacity	water volume capacity	planter ref.#	saucer ref.#
									
A	Rim 18" Planter**	17.70 in 45,0 cm	9.84 in 25,0 cm	13.00 / 8.86 in 33,0 / 22,5 cm	17.91 in 45,5 cm	5.14 gal 19,5 l	3.92 gal 14,8 l	A6045XX	A9910XXT
B	Rim 22" Planter	21.60 54,9	12.60 32,0	17.00 / 10.83 43,2 / 27,5	21.85 55,5	9.95 37,7	7.32 27,7	A6055XX	A9913XXT
C	Rim 26" Planter	25.60 65,0	14.96 38,0	21.00 / 12.80 53,3 / 32,5	25.79 65,5	17.73 67,1	11.86 44,9	A6065XX	A9915XXT
D	Rim 30" Planter	29.60 75,2	17.71 45,0	25.00 / 14.76 63,5 / 37,5	29.72 75,5	27.94 105,8	19.91 75,4	A6075XX	A9990XXT

Make sure to order mess-free drain couplings if you will be emptying water cavity on a delicate surface. See page 95.



IN-STOCK QUICK SHIP COLORS



Old Bronze Ref: 14



Caviar Black Ref: 94



Cloud White Ref: 00



Weathered Terracotta Ref: 34



Ash Ref: 98



Slate Ref: 97



Midnight Ref: 55



Olive Ref: 82



Bark Ref: 74



Currant Ref: 47

* 10 Year Limited Warranty covers planter shell only.

** This size does not include a side drain and cannot accommodate a mess free drainage system.

Slat of Planters

NEW



Slate



Slate



Slat of Planters

NEW



Caviar Black



Slat Planter Boxes

NEW



Texture Detail

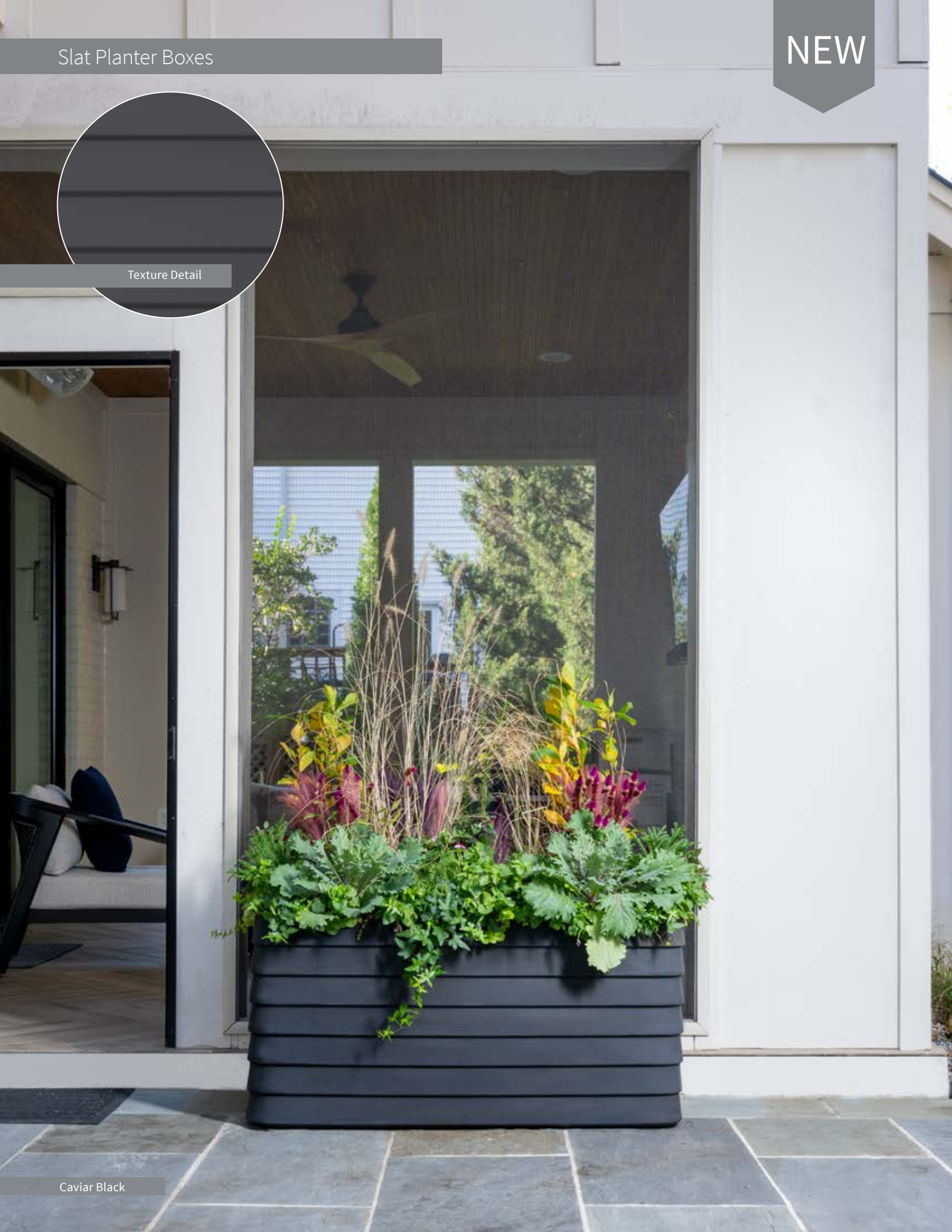

Caviar Black

	A B C	dimensions			volume capacity		planter ref.#
		soil	water				
A	Slat Square 22" Planter	22.48 x 22.48 in 57,1 x 57,1 cm	17.72 / 12.20 in 45,0 / 31,0 cm	19.69 in 50,0 cm	14.66 gal 55,5 l	10.30 gal 39,0 l	A8157XX
B	Slat Medium Deck Box 36" x 17" x 17"H Planter	35.87 x 17.95 91,1 x 45,6	31.18 / 9.09 79,2 / 23,1	16.54 42,0	15,59 59,0	11.36 43,0	A8191XX
C	Slat Large Deck Box 47" x 19" x 23"H Planter	46.65 x 19.09 118,5 x 48,5	41.89 / 15.35 106,4 / 39,0	22.83 58,0	35.53 134,5	17.38 65,8	A81118XX

Make sure to order mess-free drain couplings if you will be emptying water cavity on a delicate surface. See page 95.

Caster Plates Size Small and Anti-Theft Bracket systems available - Page 93



Caster Plates:
Order 1 unit for Small and 2 units for Medium and Large Planters.



IN-STOCK QUICK SHIP COLORS



Caviar Black Ref: 94

NEW



Shadow Ref: 95



Slate Ref: 97

NEW



Parchment Ref: 11

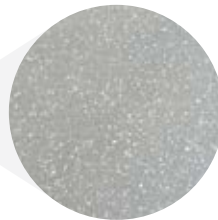

* 10 Year Limited Warranty covers planter shell only.

Slat Window Boxes

NEW

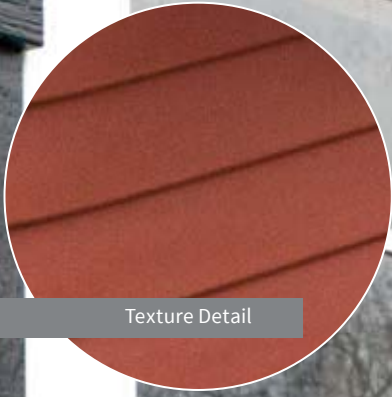

Texture Detail



Currant

	A B C	dimensions			volume capacity		planter ref.#
		soil	water				
A	Slat Small Window Box 23" x 13" x 12"H Planter	23.07 x 12.60 in 58,6 x 32,0 cm	18.70 / 6.69 in 47,5 / 17,0 cm	11.81 in 30,0 cm	4.76 gal 18,0 l	3.88 gal 14,7 l	A8258XX
B	Slat Medium Window Box 35" x 13" x 12"H Planter	34.88 x 12.60 88,6 x 32,0	30.51 / 6.69 77,5 / 17,0	11.81 30,0	7.93 30,0	5.81 22,7	A8288XX
C	Slat Large Window Box 47" x 13" x 12"H Planter	46.69 x 12.60 118,6 x 32,0	42.32 / 6.69 107,5 / 17,0	11.81 30,0	11.20 42,4	7.93 30,0	A82118XX
D	Metal Bracket for wall mounting Slat Window Boxes (Order 2 units for Small and Medium window box, order 3 for Large.)	10.14 x 0.79 25,8 x 2,0	N/A	11.81 30,3	N/A	N/A	AR07

Make sure to order mess-free drain couplings if you will be emptying water cavity on a delicate surface. See page 95.



IN-STOCK QUICK SHIP COLORS



Caviar Black Ref: 94



Cloud White Ref: 00



Slate Ref: 97

NEW



Shadow Ref: 95



Midnight Ref: 55



Olive Ref: 82







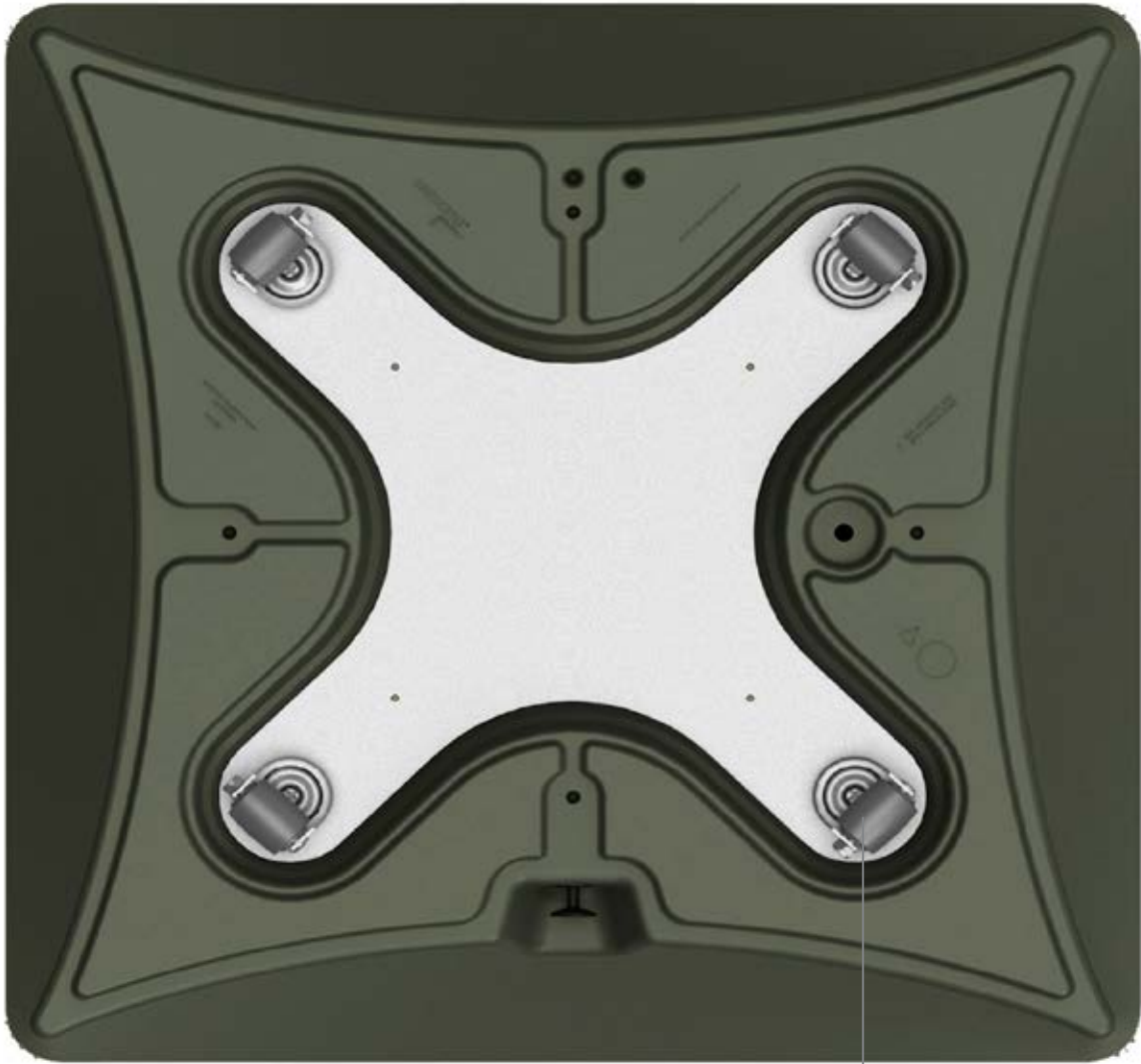







Currant Ref: 47

* 10 Year Limited Warranty covers planter shell only.



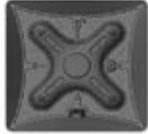

Rotating, recessed caster base
can be added for mobility.

 A	dimensions				product ref.#
					
Caster System S - for 23" Pinch Planter or Slat Planter Boxes	13.50 45,8	in cm	13.50 45,8	in cm	AR03
Caster System M - for 29" Pinch Planter	24.02 61,0		24.02 61,0		AR04
Caster System L - for 37" Pinch Planter	33.50 85,1		33.50 85,1		AR05

Caster System	Slat Planter Boxes			Pinch Planters		
	Square 22"	Medium Deck Box	Large Deck Box	23" Pinch	29" Pinch	37" Pinch
						
	x1	x2	x2	x1	-	-
	-	-	-	-	x1	-
	-	-	-	-	-	x1

TruDrop One - Add-ons for Pinch Planters and Slat Planter Boxes

	dimensions				product ref.#
					
A Anti-Theft Brackets System for Pinch Planter or Slat Planter Boxes (Set of 4)	4.64 11,8	in cm	1.10 2,8	in cm	AR06K1

Anti-theft brackets can be added to attach planter to concrete where needed.

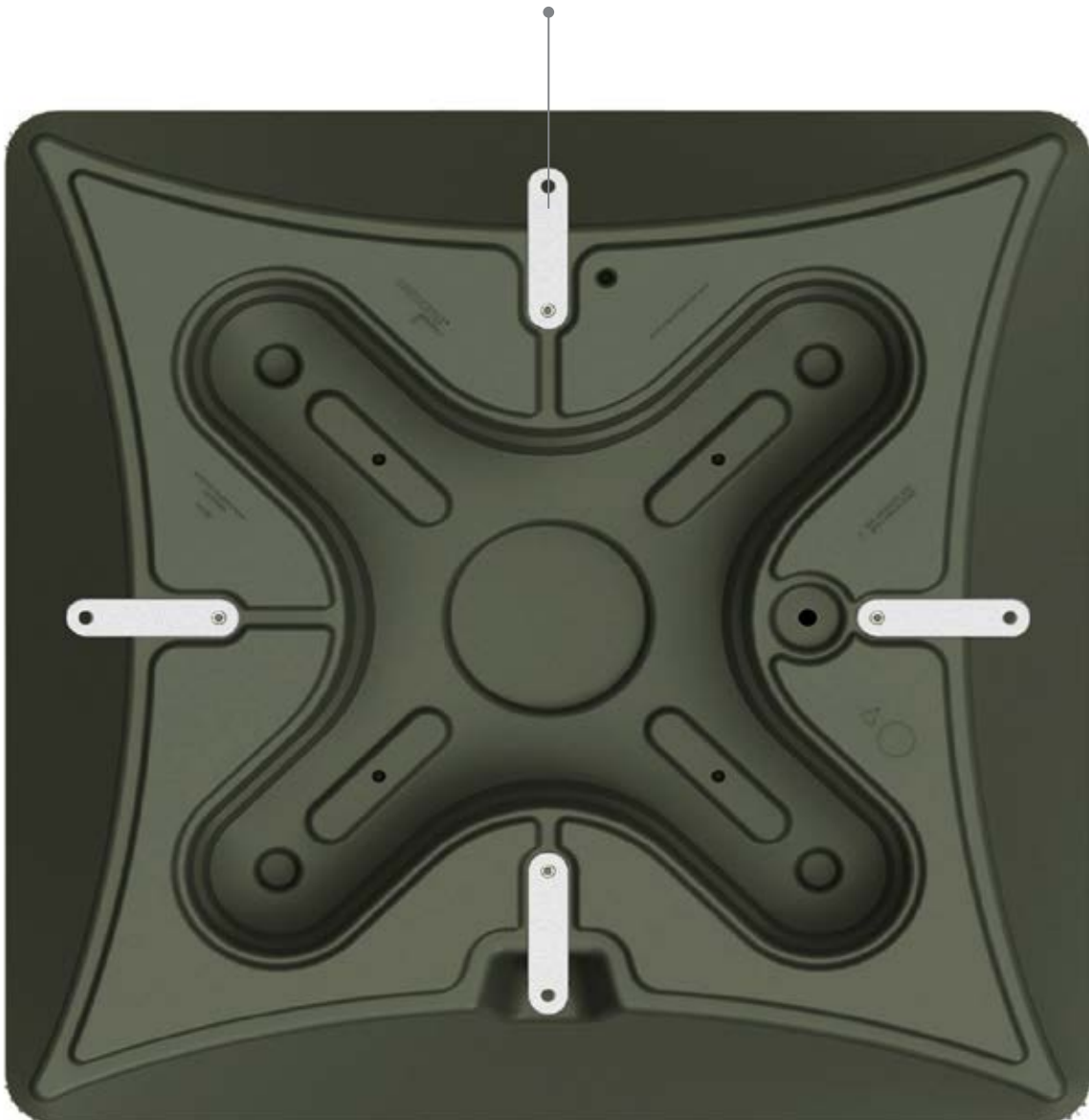

TruDrop One - Easy Drain System



	description	product ref.#
A	Coupler for use with any easy drain plug	AZ600588
B	Easy Drain barbed pull drain plug	BT002P193
C	Easy Drain Screw Plug for Legacy Planters	AZ607588

Make sure to order mess-free drain couplings if you will be emptying water cavity on a delicate surface.

How easy drain works

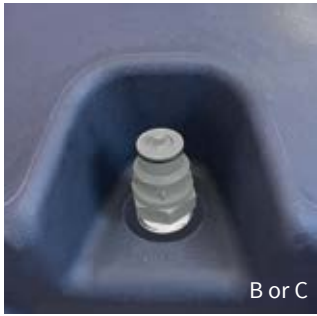

B or C

Replace the standard cap on the mouse hole opening at the bottom of the planter with the Easy Drain Screw cap or barbed pull drain cap depending on the planter selected.

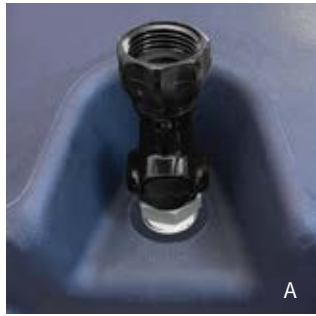

A

When you are ready to drain the planter just use the coupler to connect to a standard garden hose. Hose can then be directed to a bucket or a green area away from decks or delicate floors.



Replacement Parts for TruDrop One Planters



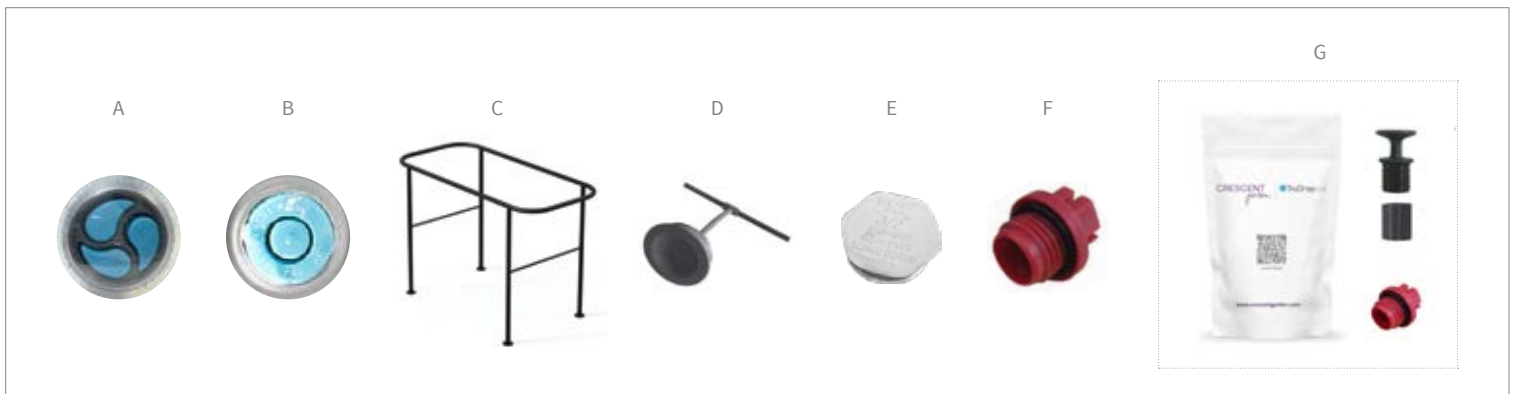

description	A - indicator ref. #	B - NEW indicator ref. #
-------------	----------------------	--------------------------

description	A - indicator ref. #	B - NEW indicator ref. #
TruDrop One Water Level Indicator		
TruDrop One Water Level Indicator for Cup 16" Planter	T01288188S	BT01742547
TruDrop One Water Level Indicator for Cup 19" Planter	T01339244S	BT01872635
TruDrop One Water Level Indicator for Cup 22" Planter	T01386287S	BT01994677
TruDrop One Water Level Indicator for Dot 16" Planter	T01152086S	BT01384251
TruDrop One Water Level Indicator for Dot 20" Planter	N/A	BT01485326
TruDrop One Water Level Indicator for Dot 26" Planter	N/A	BT01642424
TruDrop One Water Level Indicator for Mod 20" x 20" x 38"H Planter	T01375287S	BT01960770
TruDrop One Water Level Indicator for Mod 20" x 14" x 12" Planter	T01110059S	BT01290234
TruDrop One Water Level Indicator for Mod 20" x 14" x 24" Planter	T01228103S	BT01587310
TruDrop One Water Level Indicator for Mod 20" x 20" x 16" Planter	T01149093S	BT01380310
TruDrop One Water Level Indicator for Mod 40" x 14" x 30"H Planter	T01287191S	BT01732594
TruDrop One Water Level Indicator for Mod 40" x 20" x 20" Planter	T01189131S	BT01485395
TruDrop One Water Level Indicator for Small and Medium Nest	N/A	BT01389326
TruDrop One Water Level Indicator for Rim 18" Planter	N/A	BT01447326
TruDrop One Water Level Indicator for Rim 22" Planter	N/A	BT01537364
TruDrop One Water Level Indicator for Rim 26" Planter	N/A	BT01640435
TruDrop One Water Level Indicator for Rim 30" Planter	N/A	BT01742472
TruDrop One Water Level Indicator for Slat Square 22" Planter	N/A	BT01481391
TruDrop One Water Level Indicator for Slat Medium Deck Box 36" x 17" x 17"H Planter	N/A	BT01403322
TruDrop One Water Level Indicator for Slat Large Deck Box 47" x 19" x 23"H Planter	N/A	BT01558463
TruDrop One Water Level Indicator for Slat Window Box (Small, Medium and Large)	N/A	BT01282223
TruDrop One Water Level Indicator for Pinch 23" Planter	N/A	BT01502326
TruDrop One Water Level Indicator for Pinch 29" Planter	N/A	BT01647484
TruDrop One Water Level Indicator for Pinch 37" Planter	N/A	BT01834655

description	product ref.#
-------------	---------------

Leg Sets for Small Nest	
C Leg Sets for Small Nest (Replacement)	AZ651894
C Leg Sets for Medium Nest (Replacement)	AZ652294
C Leg Sets for Large Nest (Replacement)	AZ653094

Water Caps and Plugs	
D Replacement Water Cap intake	Y0000102
E Replacement White Drain Cap	805024
F Replacement Red Plug for Overflow Drain	8080
G TruDrop Pouch with Replacement Drain plug, rubber insert & red plug	C024-000



Crescent**TOO**

 **TruDrop**FLEX



New Circular Positive ™

Our TruDrop Flex planters are now made with climate-positive UBQ materials, upcycled from landfill waste, diverting harmful emissions for a positive environmental impact.

Mix and Match

Complete flexibility from grower, to garden center, to consumer. Plants can be grown in insert and covers selected to reflect desired style.

Optional TruDrop Self Watering

Purchase with insert to go weeks without watering for phenomenal results and successful gardening.

Value Solution

Single wall planters can be used on their own or with TruDrop self watering insert. Accessible to everyone.



made with **ubaq**™



Introducing
Crescent**TOO**⁺

The **first** planter **of its kind**
made with **climate-positive** UBQ™ Material
for a **planet-positive** impact

The
Circular

Positive +
Planter

PRODUCTION AND LIFECYCLE

Upcycled from waste
Reduces landfill and emissions
Re-recyclable planters

IMPACT ON SUSTAINABILITY

Material **reduces** harmful emissions
Plant-positive containers & inserts
For a **Planet-Positive** environment

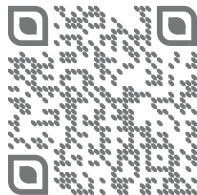

Learn More

Mix and Match

CrescentTOO | TruDrop FLEX



Find a program that works for you.



Grab and Go Containers:

Grow in nursery, display in garden center. Allow consumer to customize with their style in mind.



Build your Own:

Allow consumers to make their own TruDrop Flex self-watering container by purchasing cover and inserts in the store.



10 Year Warranty Planters:

Offer covers as stand alone containers at a great value.

Fold Planters

NOW
Sold Individually

Sleek and Simple:
Our understated Fold planter will work
in any environment.



Optional Insert:
Up to weeks without watering for
great results: TruDrop Flex.

Fold Planters



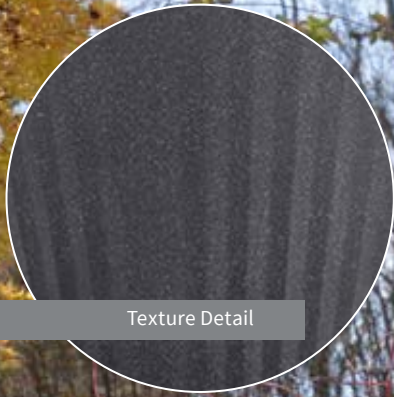

NOW
Sold Individually



Texture Detail



Bedrock Circular+

		dimensions						volume capacity	planter ref.#	
										
A	Fold 15" Planter (Small)	14.96 38,0	in cm	9.37 23,8	in cm	13.58 34,5	in cm	6.08 23,0	gal l	B09015MXXX
B	Fold 18" Planter (Medium)	18.11 46,0		9.45 24,0		16.69 42,4		10.88 41,2		B09018MXXX
C	Fold 22" Planter (Large)	22.05 56,0		13.39 34,0		19.88 50,5		19.55 74,0		B09022MXXX

Add TruDrop Flex insert for self-watering alternative. Page 115



IN-STOCK QUICK SHIP COLORS



Autumn Circular+ Ref: U33



Bedrock Circular+ Ref: U93



Juniper Circular+ Ref: U60



Coal Circular+ Ref: U94

Ridge Planters





NOW
Sold Individually



Texture Detail



Autumn Circular+

		dimensions						volume capacity	planter ref.#	
										
A	Ridge 15" Planter (Small)	14.96 38,0	in cm	8.86 22,5	in cm	13.58 34,5	in cm	5.55 21,0	gal l	B08815MXXX
B	Ridge 18" Planter (Medium)	18.11 46,0		9.45 24,0		16.69 42,4		10.30 39,0		B08818MXXX
C	Ridge 22" Planter (Large)	22.05 56,0		12.52 31,8		19.88 50,5		18.49 70,0		B08822MXXX

Add TruDrop Flex insert for self-watering alternative. Page 115



IN-STOCK QUICK SHIP COLORS



Autumn Circular+ Ref: U33



Bedrock Circular+ Ref: U93



Juniper Circular+ Ref: U60



Coal Circular+ Ref: U94

Step Planters

NOW
Sold Individually



Step into a New Age:
Inspired by mid-century design, our Step
planters are a hit with young gardeners.







Step Planters

NOW
Sold Individually

Texture Detail

Bedrock Circular+



		dimensions						volume capacity	planter ref.#	
										
A	Step 15" Planter (Small)	14.96 38,0	in cm	8.86 22,5	in cm	13.58 34,5	in cm	6.08 23,0	gal l	B08915MXXX
B	Step 18" Planter (Medium)	18.11 46,0		9.45 24,0		16.69 42,4		11.10 42,0		B08918MXXX
C	Step 22" Planter (Large)	22.05 56,0		12.87 32,7		19.88 50,5		19.81 75,0		B08922MXXX

Add TruDrop Flex insert for self-watering alternative. Page 115



TruDrop



IN-STOCK QUICK SHIP COLORS



Autumn Circular+ Ref: U33



Bedrock Circular+ Ref: U93



Juniper Circular+ Ref: U60



Coal Circular+ Ref: U94

TruDrop Flex - Insert and Water Gauge

NOW
Sold Individually

© TruDrop FLEX

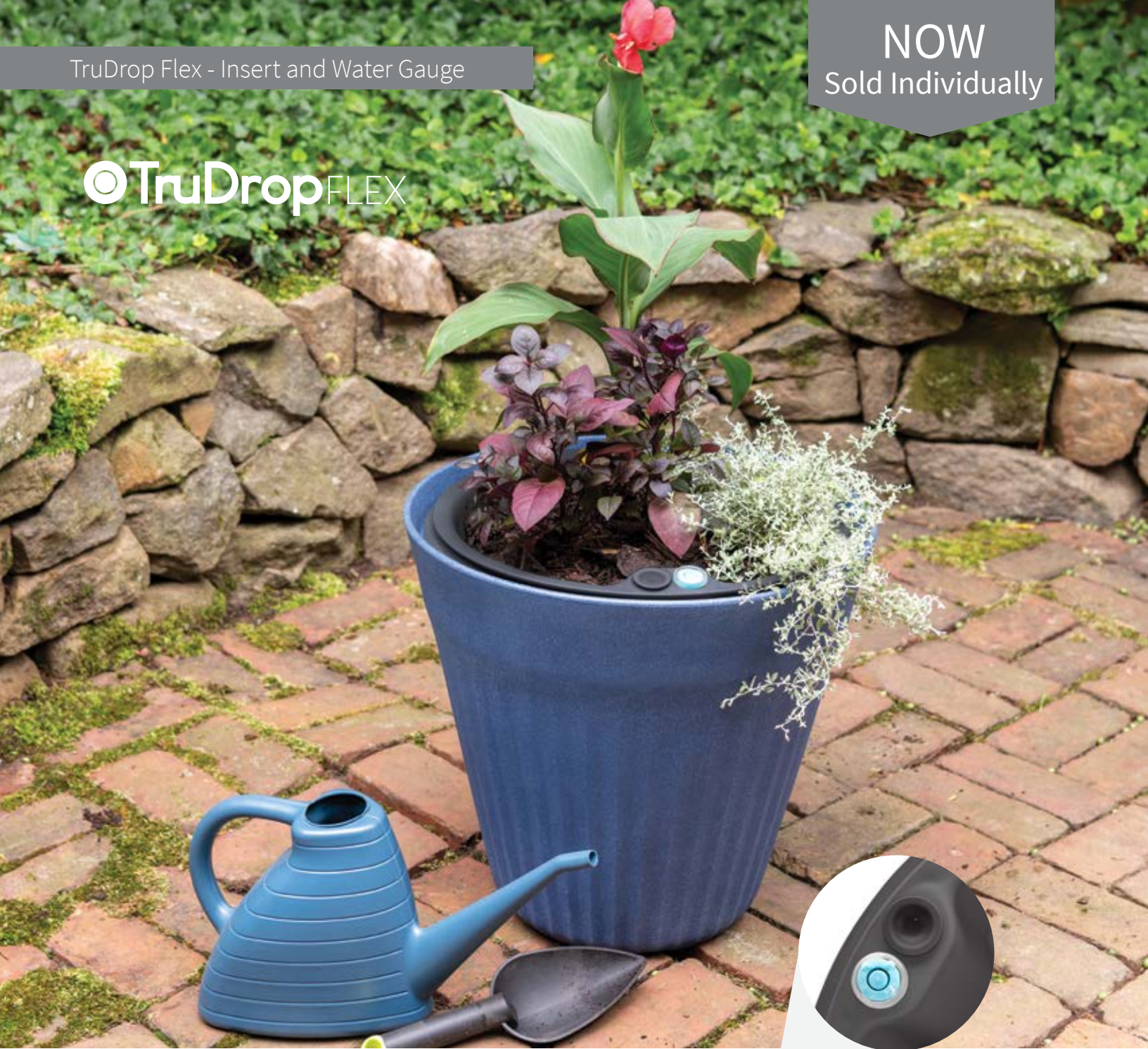

+



		dimensions			volume capacity		insert ref.#
		soil		water			
							
A	Insert, Water Gauge and Cap 15" Planters (Small)	13.54 in 34,4 cm	8.66 in 22,0 cm	12.91 in 32,8 cm	2.59 gal 9,8 l	1.74 gal 6,6 l	BT001I15193
B	Insert, Water Gauge and Cap 18" Planters (Medium)	16.69 in 42,4 cm	10.24 in 26,0 cm	15.59 in 39,6 cm	4.49 gal 17,0 l	3.70 gal 14,0 l	BT001I18193
C	Insert, Water Gauge and Cap 22" Planters (Large)	20.63 in 52,4 cm	12.20 in 31,0 cm	18.94 in 48,1 cm	9.25 gal 35,0 l	6.21 gal 23,5 l	BT001I22193



20 pcs of insert 18" are stacked, shipped inside another box

Easy to read water level indicator.

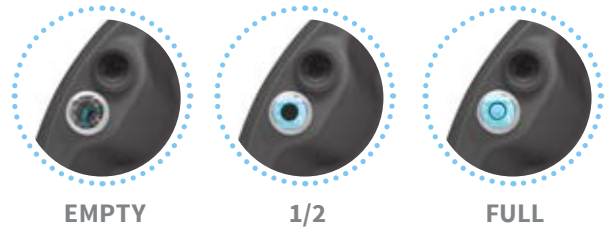



10 YEAR WARRANTY PLANTERS



Longevity

Crescent Garden rotationally molded products provide a great value to consumers given their 10 year limited warranty.

Protecting Surfaces

We offer a variety of universal saucers, caddies and other solutions to protect surfaces indoors or outdoors.

Well Designed

Every planter is detailed to deliver durability, better gardening solutions, and versatility in color and style.

100% Recyclable

All our products are manufactured with polymer type ♻️ and can be recycled.

What makes our Planters Unique

Double Wall

To protect roots from extreme temperatures, select our double wall planters that have a pocket of air between roots and the external wall.

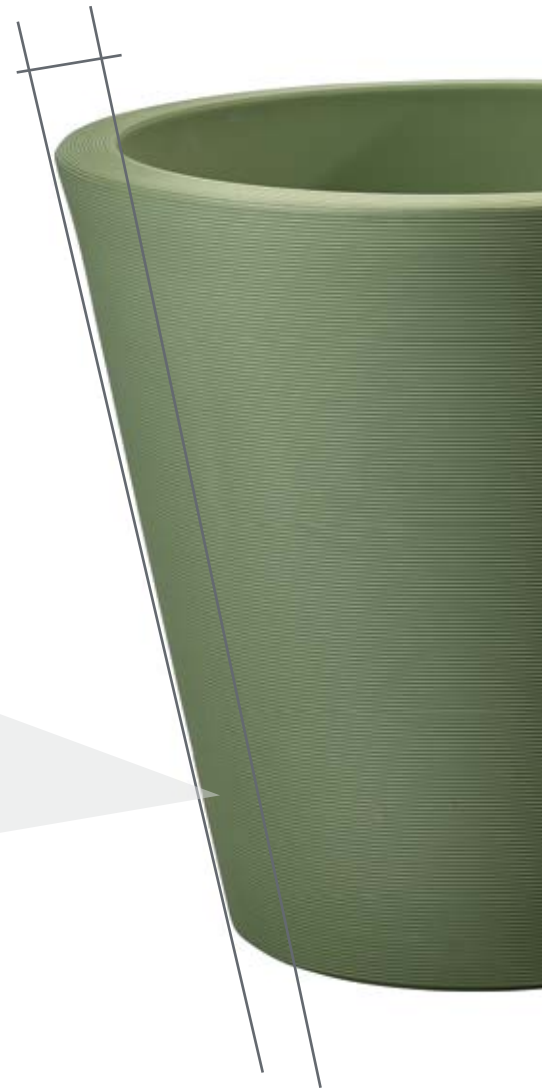

Lightweight

Our planters will make install a worry free process. We will make sure everything arrives to site intact and you won't need a large crew to get started.



10 Year Warranty

Our 10 Year Warranty against fading, or cracking will guarantee that you won't have complaints down the road.



Drainage

Healthy plants start with proper drainage. We design ours with elevated pot feet and drainage holes that are adequately sized for each planter.



Variety

Every style is available in stock in a curated selection of finishes, offering designers variety.

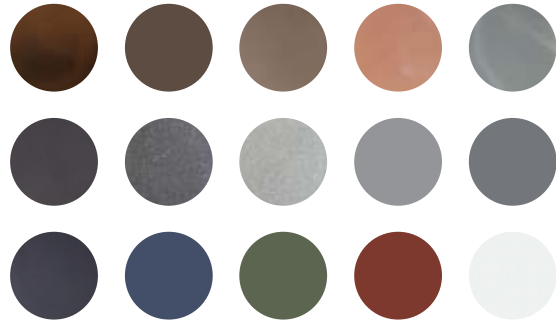

Bowls

Bowls have so many uses in a garden setting we wanted to make sure to provide you with a solution that works for all of those; our plugs allow you to easily change a bowl from a succulent garden, to a water garden or convert it into a bubbling fountain.



Use regular plug
for water gardens.



Use plug with hole
for fountains.



Use with no plug
for planting.



Gravity Cavity

Tall planters can be challenging in windy areas, so we designed ours with an internal cavity that can be filled with sand to weigh them down.

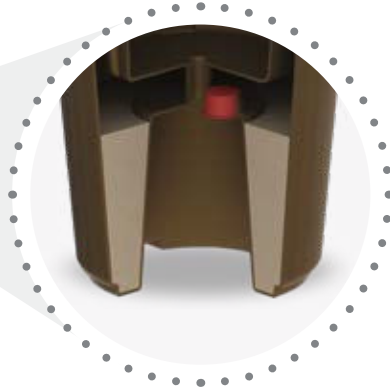

Attainable Design

Many of our planters are designed with a single wall for a value oriented option that still has a 10 Yr Warranty.





Designing with Plants:
Carefully curated containers create a mini-garden
to soften hardscapes.



Young and Hip:
This step planter targets newbies who are looking for design.



Cityscapes:
Lightweight planters are ideal for rooftops and balconies where weight can be a concern.



Commercial Applications:
The Bowery planters are ideal to create visual boundaries in open spaces.



Entryway Solutions:
Our Leyla urn is perfect for those looking for a classic style at their doorstep.



Simplicity:
Adding green in narrow spaces is easily achieved with an oval shaped planter.





Agave Planters



Texture Detail



Caviar Black

		dimensions				volume capacity	planter ref.#	saucer ref.#
								
A	Agave 14" Planter	13.75 in 34,9 cm	7.75 in 19,7 cm	11.75 in 29,8 cm	11.00 in 27,9 cm	4.50 gal 17,0 l	A1935XX	A9910XXT
B	Agave 18" Planter	17.75 45,1	10.25 26,0	15.00 38,1	13.50 34,3	9.00 34,1	A1945XX	A9913XXT
C	Agave 21" Planter	21.73 55,2	12.25 31,1	19.00 48,3	17.25 43,8	17.75 67,2	A1950XX	A9915XXT

10Year
Limited
Warranty

IN-STOCK QUICK SHIP COLORS



Caviar Black Ref: 94



Parchment Ref: 11



Rust Ref: 33

Bleeker Planters



Texture Detail









Old Bronze



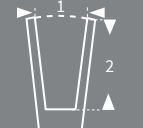

Caviar Black



Mocha

		dimensions				volume capacity	planter ref.#	saucer ref.#
								
A	Bleeker 13" Planter	13.19 in 33,5 cm	8.60 in 21,8 cm	10.21 / 17.75 in 25,9 / 45,1 cm	25.50 in 64,8 cm	4.5 gal 17,0 l	A3933XX	A9910XXT
B	Bleeker 15" Planter	15.28 38,8	9.53 24,2	11.80 / 21.75 30,0 / 55,2	31.20 79,2	7.2 27,3	A3938XX	A9910XXT
C	Bleeker 17" Planter	17.13 43,5	10.82 27,5	13.65 / 24.75 34,7 / 62,9	35.00 88,9	11.00 41,6	A3943XX	A9910XXT

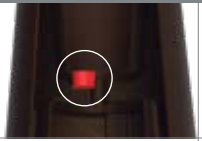
This planter can be filled with sand for additional stability:

		
Place planter upside down.	Remove red plug.	Use a funnel to fill cavity with sand. Replug and turn right side up.



IN-STOCK QUICK SHIP COLORS



Old Bronze Ref: 14



Caviar Black Ref: 94



Slate Ref: 97

Bowery Planters



Silt and Lavender





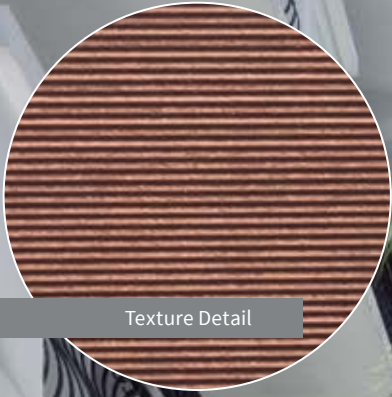



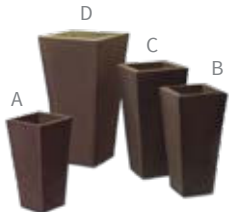

Bowery Planters





Texture Detail



		dimensions				volume capacity	planter ref.#	saucer ref.#
								
A	Bowery 13" Planter	13.00 in 33,0 cm	8.55 in 21,7 cm	10.50 / 17.69 in 26,7 / 44,9 cm	25.50 in 64,8 cm	6.00 gal 22,7 l	A5110XX	A9822XXT
B	Bowery 15" Planter	14.80 37,6	9.71 24,7	11.00 / 18.00 27,9 / 45,7	30.77 78,2	7.50 28,4	A5138XX	A9827XXT
C	Bowery 17" Planter	17.00 43,2	10.78 27,4	13.00 / 20.00 33,0 / 50,8	34.70 88,1	12.00 45,4	A5143XX	A9832XXT
D	Bowery 22" Planter	22.00 55,9	14.08 35,8	17.90 / 26.60 45,5 / 67,6	43.20 109,7	29.00 109,8	A5155XX	A9841XXT

This planter can be filled with sand for additional stability:

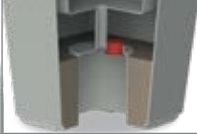
		
Place planter upside down.	Remove red plug.	Use a funnel to fill cavity with sand. Replug and turn right side up.



IN-STOCK QUICK SHIP COLORS



Old Bronze Ref: 14



Caviar Black Ref: 94



Mocha Ref: 44



Slate Ref: 97





Brunello Rolled-Rim Planters



Texture Detail



Caviar Black

		dimensions				volume capacity	planter ref.#	saucer ref.#
								
A	Brunello Rolled-Rim 12" Planter	11.40 in 29,0 cm	6.50 in 16,5 cm	9.68 in 24,6 cm	9.25 in 23,5 cm	2.25 gal 8,5 l	A2630XX	A9908XXT
B	Brunello Rolled-Rim 14" Planter	13.50 34,3	8.00 20,3	11.40 29,0	10.75 27,3	3.50 13,2	A2635XX	A9908XXT
C	Brunello Rolled-Rim 16" Planter	16.00 40,6	9.50 24,1	13.50 34,3	12.50 31,8	5.75 21,8	A2640XX	A9910XXT
D	Brunello Rolled-Rim 20" Planter	20.00 50,8	12.00 30,5	17.70 45,0	15.75 40,0	11.75 44,5	A2650XX	A9913XXT
E	Brunello Rolled-Rim 27" Planter	27.36 69,5	16.00 40,6	23.70 60,2	21.50 54,6	41.50 157,1	A2668XX	A9918XXT
F	Brunello Rolled-Rim 31" Planter	31.50 80,0	17.75 45,1	27.40 69,6	25.00 63,5	44.50 168,5	A2680XX	A9985XXT
G	Brunello Rolled-Rim 35" Planter	35.00 88,9	20.25 51,4	31.20 79,2	28.75 73,0	69.00 261,2	A2690XX	A9990XXT
H	Brunello Rolled-Rim Wide Bottom Commercial 37" Planter**	37.00 94,0	24.25 61,6	34.20 86,9	28.75 73,0	84.00 318,0	A2695XX	N/A
I	Brunello Rolled-Rim Wide Bottom Commercial 44" Planter**	44.00 111,8	28.25 71,8	40.47 102,8	34.00 86,4	139.25 527,1	A26110XX	N/A

10Year
Limited
Warranty

IN-STOCK QUICK SHIP COLORS



Caviar Black Ref: 94**



Weathered Concrete Ref: 92



Parchment Ref: 11



Rust Ref: 33



Weathered Terracotta Ref: 34**

** Please note that the 37" and 44" planters are only available in stock in Weathered Terracotta and Caviar Black, but can be special ordered in any of our finishes.





Delano Planters





Texture Detail



Slate

		dimensions				volume capacity	planter ref.#	saucer ref.#
								
A	Delano 16" Planter	15.75 in 40,0 cm	7.00 in 17,8 cm	13.70 / 6.30 in 34,8 / 16,0 cm	7.80 in 19,8 cm	2.25 gal 8,5 l	A5340XX	A9908XXT
B	Delano 20" Planter	20.00 50,8	8.10 20,6	17.70 / 7.48 45,0 / 19,0	10.00 25,4	4.50 17,0	A5350XX	A9910XXT
C	Delano 26" Planter	26.00 66,0	10.50 26,7	23.70 / 9.84 60,2 / 25,0	13.00 33,0	10.75 40,7	A5366XX	A9913XXT
D	Delano 34" Planter*	33.70 85,6	13.70 34,8	31.70 / 13.78 80,5 / 35,0	17.00 43,2	24.00 90,8	A5386XX	A9915XXT

***Plug System Included for 34" Bowl**

		
Use regular plug for water gardens.	Use plug with hole for fountains.	Use with no plug for planting.



IN-STOCK QUICK SHIP COLORS



Old Bronze Ref: 14



Caviar Black Ref: 94



Mocha Ref: 44



Slate Ref: 97



Midnight Ref: 55





Delano Oval Bowls





Texture Detail

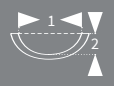

Slate

		dimensions				volume capacity	planter ref.#
							
A	Delano Oval 24" Bowl	24.00 x 17.00 in 61,0 x 43,2 cm	14.10 x 10.00 in 35,8 x 25,4 cm	21.50 x 14.50 / 5.91 in 54,6 x 36,8 / 15,0 cm	8.00 in 20,3 cm	3.75 gal 14,2 l	A5460XX
B	Delano Oval 30" Bowl	30.00 x 21.10 76,2 x 53,6	16.30 x 11.60 41,4 x 29,5	27.40 x 18.70 / 7.28 69,6 x 47,5 / 18,5	10.00 25,4	7.75 29,3	A5476XX

Plug System Included		
		
Use regular plug for water gardens.	Use plug with hole for fountains.	Use with no plug for planting.



IN-STOCK QUICK SHIP COLORS



Old Bronze Ref: 14



Caviar Black Ref: 94



Mocha Ref: 44



Slate Ref: 97







Midnight Ref: 55

Delano Tall Planters

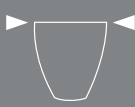

Texture Detail



		dimensions				volume capacity	planter ref.#	saucer ref.#
								
A	Delano Tall 16" Planter	16.00 in 40,6 cm	7.10 in 18,0 cm	13.10 / 12.20 in 33,3 / 31,0 cm	17.60 in 44,7 cm	4.50 gal 17,0 l	A5540XX	A9908XXT



IN-STOCK QUICK SHIP COLORS



Old Bronze Ref: 14



Caviar Black Ref: 94



Mocha Ref: 44



Slate Ref: 97



Midnight Ref: 55

Eye Planters



Cloud White



Eye Planters



Texture Detail



Caviar Black

		dimensions				volume capacity	planter ref.#
A	Eye Ain't 26" Planter	26.30 in 66,8 cm	21.85 in 55,5 cm	13.60 / 17.09 in 34,5 / 43,4 cm	18.70 in 47,5 cm	9.25 gal 35,0 l	A7966XX
B	Eye Am 26" Planter	26.00 66,0	21.00 53,3	21.90 x 14.50 / 22.76 55,6 x 36,8 / 57,8	24.60 62,5	13.00 49,2	A7866XX



IN-STOCK QUICK SHIP COLORS



Caviar Black Ref: 94



Cloud White Ref: 00



Slate Ref: 97

Fold Planters







NOW
Sold Individually



Texture Detail



Bedrock Circular+

		dimensions						volume capacity		planter ref.#
										
A	Fold 15" Planter (Small)	14.96 38,0	in cm	9.37 23,8	in cm	13.58 34,5	in cm	6.08 23,0	gal l	B09015MXXX
B	Fold 18" Planter (Medium)	18.11 46,0		9.45 24,0		16.69 42,4		10.88 41,2		B09018MXXX
C	Fold 22" Planter (Large)	22.05 56,0		13.39 34,0		19.88 50,5		19.55 74,0		B09022MXXX

Add TruDrop Flex insert for self-watering alternative. Page 115



IN-STOCK QUICK SHIP COLORS



Autumn Circular + Ref: U33



Bedrock Circular Ref: U93



Juniper Circular + Ref: U60



Coal Circular + Ref: U94







Leyla Urn



Texture Detail

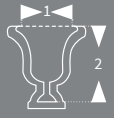

Caviar Black

	dimensions						volume capacity	planter ref.#
								
A Leyla Urn	22.20 in 56,4 cm	13.75 x 14.00 in 34,9 x 35,6 cm	18.85 / 12.40 in 47,9 / 31,5 cm	28.25 in 71,8 cm		23.25 gal 88,0 l	A6955XX	



IN-STOCK QUICK SHIP COLORS



Caviar Black Ref: 94



Mocha Ref: 44

...wants
...I want
...the rare yarbubir julung, a bollyn is dearest fit
...re mullory Molly are the big ideas mullion
...Turkey the favourite game off the always d
...he a beautifyn Torrenfino is very you interest
...memory called the memo super it million
...favourite. You don't na a famous people
...y called kind girl somebody went many
...you sorry for my Endun, some
...ful, colored don't coffe as m
...ful, colored don't coffe as m
...somebody
...somebody
...feeling it
...to go. A
...memorie
...Somebody
...nation celore







Madison Planters



Texture Detail

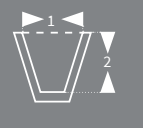

Slate

		dimensions				volume capacity	planter ref.#	saucer ref.#
								
A	Madison 14" Planter	14.00 in 35,6 cm	8.73 in 22,2 cm	12.01 / 10.93 in 30,5 / 27,8 cm	14.00 in 35,6 cm	3.44 gal 13,0 l	A1135XXA	A9910XXT
B	Madison 16" Planter	16.00 40,6	10.03 25,5	13.60 / 12.48 34,5 / 31,7	16.00 40,6	5.09 19,3	A1140XXA	A9910XXT
C	Madison 20" Planter	20.00 50,8	12.28 31,2	17.46 / 15.61 44,3 / 39,6	20.00 50,8	10.71 40,5	A1150XXA	A9913XXT
D	Madison 26" Planter	26.00 66,0	16.04 40,7	22.21 / 18.24 56,4 / 46,3	26.00 66,0	20.85 78,9	A1165XXA	A9918XXT
E	Madison 34" Planter	34.00 86,4	21.04 53,4	29.39 / 23.67 74,7 / 60,1	34.00 86,4	48.59 183,9	A1180XXA	A9990XXT
F	Madison 48" Planter *	48.20 122,5	29.10 74,0	33.00 / 41.70 84,0 / 106,0	47.40 120,5	170.00 650,0	A11125XX	N/A



IN-STOCK QUICK SHIP COLORS



Old Bronze Ref: 14



Caviar Black Ref: 94



Cloud White Ref: 00



Mocha Ref: 44



Weathered Terracotta Ref: 34



Slate Ref: 97



Midnight Ref: 55



Olive Ref: 82



Bark Ref: 74

*Please note that the 48" planter is only available in Caviar Black in stock but can be special ordered in all our other finishes.







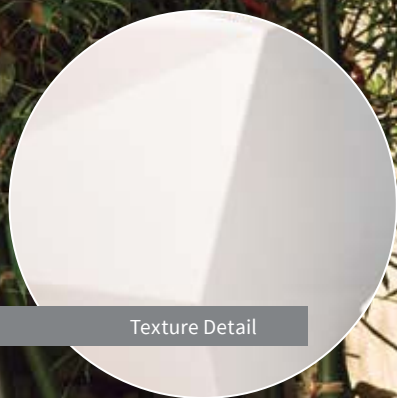



Origami Planters



Texture Detail

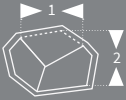

Cloud White

		dimensions						volume capacity	planter ref.#
									
A	Origami 23" Planter	23.00 in 58,4 cm	23.00 in 58,4 cm	13.50 x 12.50 / 10.05 in 34,3 x 31,8 / 25,5 cm	14.50 in 36,8 cm	6.50 gal 24,6 l	A5658XX		
B	Origami 26" Tall Planter	25.75 65,4	25.75 65,4	17.00 x 16.00 / 17.80 43,2 x 40,6 / 45,2	25.00 63,5	13.50 51,1	A5766XX		



IN-STOCK QUICK SHIP COLORS



Caviar Black Ref: 94



Cloud White Ref: 00



Ash Ref: 98



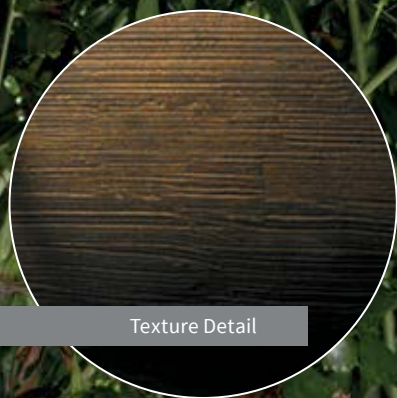





Orinoco Bowls





Texture Detail



Old Bronze

		dimensions						volume capacity	planter ref.#
									
A	 Orinoco 21" Bowl	21.00 in 53,3 cm	8.25 in 21,0 cm	19.75 / 5.71 in 50,2 / 14,5 cm	8.25 in 21,0 cm	6.25 gal 23,7 l	A4655XX		
B	Orinoco 30" Bowl*	31.75 80,6	16.50 41,9	29.00 / 8.46 73,7 / 21,5	12.00 30,5	19.25 72,9	A4680XX		
C	Orinoco 40" Bowl*	39.75 101,0	20.50 52,1	36.75 / 10.63 93,3 / 27,0	15.00 38,1	40.75 154,3	A46100XX		

***Plug System Included for 30" and 40" Bowls**

		
Use regular plug for water gardens.	Use plug with hole for fountains.	Use with no plug for planting.



IN-STOCK QUICK SHIP COLORS



Old Bronze Ref: 14



Caviar Black Ref: 94



Weathered Concrete Ref: 92

Pleat Planters







**ROOFTOP BAR
NOW OPEN**

39







Pleat Planters

Texture Detail

Olive



		dimensions				volume capacity	planter ref.#	saucer ref.#
								
A	Pleat 15" Planter	15.00 in 38,1 cm	7.48 in 19,0 cm	14.45 in 36,7 cm	15.00 in 38,1 cm	7.40 gal 28,0 l	A6638XX	A9908XXT
B	Pleat 19" Planter	19.00 48,3	9.25 23,5	18.43 46,8	19.00 48,3	14.53 55,0	A6648XX	A9910XXT
C	Pleat 23" Planter	23.00 58,4	11.42 29,0	22.01 55,9	23.00 58,4	26.81 101,5	A6658XX	A9913XXT
D	Pleat Tall 23" Planter	23.00 58,4	11.42 29,0	22.01 55,9	27.00 68,6	32.10 121,5	A6659XX	A9913XXT
E	Pleat 27" Planter	27.00 68,6	14.17 36,0	26.42 67,1	27.00 68,6	46.23 175,0	A6668XX	A9915XXT
F	Pleat Tall 27" Planter	27.00 68,6	14.17 36,0	26.42 67,1	32.00 81,3	54.95 208,0	A6669XX	A9915XXT

10Year
Limited
Warranty

IN-STOCK QUICK SHIP COLORS



Caviar Black Ref: 94



Cloud White Ref: 00



Weathered Terracotta Ref: 34



Ash Ref: 98



Slate Ref: 97



Midnight Ref: 55



Olive Ref: 82



Bark Ref: 74

Ridge Planters







NOW
Sold Individually



Texture Detail



Autumn Circular+

		dimensions						volume capacity		planter ref.#
										
A	Ridge 15" Planter (Small)	14.96 38,0	in cm	8.86 22,5	in cm	13.58 34,5	in cm	5.55 21,0	gal l	B08815MXXX
B	Ridge 18" Planter (Medium)	18.11 46,0		9.45 24,0		16.69 42,4		10.30 39,0		B08818MXXX
C	Ridge 22" Planter (Large)	22.05 56,0		12.52 31,8		19.88 50,5		18.49 70,0		B08822MXXX

Add TruDrop Flex insert for self-watering alternative. Page 115



IN-STOCK QUICK SHIP COLORS



Autumn Circular + Ref: U33



Bedrock Circular Ref: U93



Juniper Circular + Ref: U60



Coal Circular + Ref: U94

Step Planters





NOW
Sold Individually



Texture Detail



Bedrock Circular+

		dimensions						volume capacity	planter ref.#	
										
A	Step 15" Planter (Small)	14.96 38,0	in cm	8.86 22,5	in cm	13.58 34,5	in cm	6.08 23,0	gal l	B08915MXXX
B	Step 18" Planter (Medium)	18.11 46,0		9.45 24,0		16.69 42,4		11.10 42,0		B08918MXXX
C	Step 22" Planter (Large)	22.05 56,0		12.87 32,7		19.88 50,5		19.81 75,0		B08922MXXX

Add TruDrop Flex insert for self-watering alternative. Page 115



IN-STOCK QUICK SHIP COLORS



Autumn Circular + Ref: U33



Bedrock Circular Ref: U93



Juniper Circular + Ref: U60



Coal Circular + Ref: U94



Crescent**TOO**

EVERYDAY PLANTERS



Lightweight and Durable

Just like our traditional Crescent Garden planters these new products represent great quality in their category.

Modern Design

Our selection of sleek designs brings a new look to everyday garden products.

Great for Interiors and Exteriors

These planters are all available in stock with no holes making them ideal for use as cache-pots for smaller plants.



Great Merchandising Ideas

Bright colors and fun styles makes it easy to create attractive in store displays.

Smaller Sizes

Crescent Too planters start at 5" in diameter.

2 Year Limited Warranty

Our Crescent Too planters are durable in construction and many have a 2 year limited warranty.

Eva Planters







Texture Detail

Gold



White and Fudge

		dimensions						volume capacity	planter ref.#	
										
A	Eva 5.5" Planter (Case of 6)	5.50 14,0	in cm	4.00 10,2	in cm	5.20 13,2	in cm	0.45 1,7	gal l	AZ0105XXC
B	Eva 6.3" Planter (Case of 4)	6.30 16,0		4.50 11,4		5.90 15,0		0.58 2,2		AZ0106XXC
C	Eva 7.1" Planter (Case of 6)	7.10 18,0		5.00 12,7		6.50 16,5		0.92 3,5		AZ0107XXC
D	Eva 8.6" Planter (Case of 6)	8.60 21,8		6.30 16,0		7.90 20,1		1.40 6,3		AZ0109XXC
E	Eva 9.4" Planter (Case of 4)	9.40 23,9		6.80 17,3		8.80 22,4		2.15 8,2		AZ0110XXC
F	Eva 11.0" Planter (Case of 2)	11.00 27,9		7.50 19,1		9.00 22,9		2.30 10,0		AZ0111XXC
G	Eva 12.0" Planter (Case of 2)	11.50 29,2		8.00 20,3		9.75 24,8		3.20 12,0		AZ0112XXC
H	Eva 13.0" Planter (Case of 2)	12.87 32,7		9.00 22,9		11.00 27,9		4.60 17,5		AZ0114XXC
I	Eva 14.0" Planter (Case of 2)	14.25 36,2		10.00 25,4		13.00 33,0		6.80 26,0		AZ0116XXC
J	Eva 18.0" Planter (Sold Individually)	17.75 45,1		12.00 30,5		15.00 38,1		11.00 44,0		AZ0118XX



IN-STOCK QUICK SHIP COLORS



White Ref: 00



Latte Ref: 70



Fudge Ref: 72



Black Ref: 94



Display Available - Page 169



MOBILITY AND DRAINAGE SOLUTIONS



Successful Gardening

We know drainage is essential to healthy plants, but protecting surfaces is also important so we offer a variety of solutions to make it happen.

Innovative Solutions

Maintaining proper drainage is indispensable for the survival of containerized plants. Our accessories present a variety of innovative solutions.

Movable Planters

Once potted large planters can be heavy. Add mobility to some of our planters with our casters, to clean and transform spaces easily.

Pebble Plant Caddies







These planters can move:
Hidden casters make it easy to clean or move
your plants as the seasons change.



Pebble Plant Caddies



Cloud White, Caviar Black, Currant and Ash

		dimensions				product ref.#
						
A	Pebble Small Plant Caddy	15.91 x 15.04 40,4 x 38,2	in cm	4.37 11,1	in cm	A8040XXR
B	Pebble Medium Plant Caddy	19.45 x 17.09 49,4 x 43,4		3.98 10,1		A8050XXR
C	Pebble Large Plant Caddy	23.39 x 19.69 59,4 x 50,0		3.58 9,1		A8060XXR

Caddies can easily support 200 pounds.



10Year*
Limited
Warranty

IN-STOCK QUICK SHIP COLORS



Caviar Black Ref: 94



Cloud White Ref: 00



Ash Ref: 98



Slate Ref: 97



Midnight Ref: 55



Olive Ref: 82



Bark Ref: 74







Currant Ref: 47

* 10 Year Limited Warranty for indoor use.

Universal Round Saucers



		dimensions						product ref.#
								
A	8" Circular Universal Saucer	11.00 27,9	in cm	1.00 2,5	in cm	8.50 21,6	in cm	A9908XXT
B	11" Circular Universal Saucer	15.00 38,1		1.50 3,8		11.00 27,9		A9910XXT
C	13" Circular Universal Saucer	18.00 45,7		2.00 5,1		13.25 33,7		A9913XXT
D	15" Circular Universal Saucer	20.00 50,8		2.00 5,1		15.50 39,4		A9915XXT
E	18" Circular Universal Saucer	23.50 59,7		2.50 6,4		18.50 47,0		A9918XXT
F	19.7" Circular Universal Saucer	22.00 55,9		2.38 6,0		19.75 50,2		A9985XXT
G	22.8" Circular Universal Saucer	25.50 64,8		2.38 6,0		23.00 58,4		A9990XXT
H	NEW Assorted Bundle Pack of Universal Saucers (Caviar Black or Weathered Terracotta) Includes: 20 ea of 8", 11" & 13", and 10 ea of 15" & 18"							A9988XXT

10Year
Limited
Warranty

IN-STOCK QUICK SHIP COLORS

			8" Saucer	11" Saucer	13" Saucer	15" Saucer	18" Saucer	19.7" Saucer	22.8" Saucer
	Ref: 00	Cloud White	✓	✓	✓	✓	✓	✓	✓
	Ref: 92	Weathered Concrete	✓	✓	✓	✓	✓	✓	✓
	Ref: 98	Ash	✓	✓	✓	✓	✓	✓	✓
	Ref: 97	Slate	✓	✓	✓	✓	✓	✓	✓
	Ref: 14	Old Bronze	✓	✓	✓	✓	✓	✓	✓
	Ref: 94	Caviar Black	✓	✓	✓	✓	✓	✓	✓
	Ref: 33	Rust	✓	✓	✓	✓	✓	✓	✓
	Ref: 74	Bark	✓	✓	✓	✓	✓		✓
	Ref: 44	Mocha	✓	✓	✓	✓	✓	✓	✓
	Ref: 34	Weathered Terracotta	✓	✓	✓	✓	✓	✓	✓
	Ref: 11	Parchment	✓	✓	✓	✓	✓	✓	✓
	Ref: 82	Olive	✓	✓	✓	✓	✓		✓
	Ref: 55	Midnight	✓	✓	✓	✓	✓		✓
	Ref: 55	Shadow							

Universal Square Saucers



		dimensions						product ref.#
A	9" Square Universal Saucer	12.50 x 12.50 in 31,8 x 31,8 cm	1.00 in 2,5 cm	9.00 x 9.00 in 22,9 x 22,9 cm		A9822XXT		
B	11" Square Universal Saucer	14.50 x 14.50 in 36,8 x 36,8 cm	1.25 in 3,2 cm	11.20 x 11.20 in 28,4 x 28,4 cm		A9827XXT		
C	13" Square Universal Saucer	16.75 x 16.75 in 42,5 x 42,5 cm	1.25 in 3,2 cm	13.25 x 13.25 in 33,7 x 33,7 cm		A9832XXT		
D	16" Square Universal Saucer	19.75 x 19.75 in 50,2 x 50,2 cm	1.50 in 3,8 cm	16.25 x 16.25 in 41,3 x 41,3 cm		A9841XXT		
E	NEW Assorted Bundle Pack of Square Saucers (Caviar Black or Weathered Terracotta) Includes: 20 ea of 9" & 11" and 10 ea of 13" & 16"					A9888XXT		

10Year
Limited
Warranty

IN-STOCK QUICK SHIP COLORS

			9" Saucer	11" Saucer	13" Saucer	16" Saucer
	Ref: 00	Cloud White	✓	✓	✓	✓
	Ref: 92	Weathered Concrete	✓	✓	✓	✓
	Ref: 98	Ash	✓	✓	✓	✓
	Ref: 97	Slate	✓	✓	✓	✓
	Ref: 14	Old Bronze	✓	✓	✓	✓
	Ref: 94	Caviar Black	✓	✓	✓	✓
	Ref: 33	Rust	✓	✓	✓	✓
	Ref: 74	Bark				
	Ref: 44	Mocha	✓	✓	✓	✓
	Ref: 34	Weathered Terracotta	✓	✓	✓	✓
	Ref: 11	Parchment	✓	✓	✓	✓
	Ref: 82	Olive				
	Ref: 55	Midnight				
	Ref: 55	Shadow				



we help you grow

